



User Manual

S5-TCP/IP 100

Ethernet CP for Simatic S5

Manual Version HB200400001E-0307-001

S5-TCP/IP 100 

COPYRIGHT

The contents of this manual and the related configuration software are the property of INAT GmbH. This material is subject to the conditions of a general or special license contract (one-time license), and may only be used or reproduced when the terms of agreement as set forth in this contract are fulfilled.

The specifications in these documents are provided without responsibility for errors or omissions.

The contents are subject to change without prior notice. The contents are subject to change due to technical advance.

© Copyright INAT GmbH 1996-2007

Industrial Networks for Automation Technology
Ostendstrasse 50A
90482 Nuremberg
Germany
Tel: + 49 911 / 5 44 27-0
Fax: + 49 911 / 5 44 27-27
Web: www.inat.de
Email: Info@inat.de

All rights reserved

NOTE

Please read the manual before using INAT S5-TCP/IP 100. In case of damage caused by misuse of this product, we assume no liability.

The recent version of this manual is available in the Download Area of INAT at www.inat.de

Simatic[®], Step[®] and Sinec[®] are registered trademarks of the Siemens AG.

CONTENTS

1 GENERAL	6
1.1 Scope of supply	6
1.2 Specifications	6
1.3 Compatibility with S5-TCP/IP	7
2 HARDWARE	10
2.1 Overview	10
2.1.1 Compact Flash	11
2.1.2 Reset	11
2.1.3 LEDs	11
2.1.4 Switch	12
2.1.5 PG interface (AS511 interface)	12
2.1.6 Jumper 1100	14
2.2 Installation	15
2.2.1 Installing the S5-TCP/IP 100 in the PLC rack	15
2.2.2 Connecting the CP to Ethernet and connecting further Ethernet components	15
2.2.3 Connecting the CP to PC/PG	15
3 FUNCTION OF THE S5-TCP/IP 100	18
3.1.1 Handling blocks	18
3.1.2 Supplying Parameters for handling blocks (HDBs)	20
3.1.3 Functionality of handling blocks	20
3.3 Job types	23
3.3.1 SEND / RECEIVE	23
3.3.2 WRITE active / WRITE passive	24
3.3.3 FETCH active / FETCH passive	25
3.3.4 FETCH on EVENT passive	26
3.4 Connections	27
3.4.1 H1 connection	27
3.4.2 TCP/IP Connection	29
3.4.3 Difference: TCP/IP - H1	31
3.4.4 RFC1006	32
3.4.5 INAT PLC Header	32
3.5 Nomenclature INAT – Siemens	34
3.6 Function of the Switch	34
3.6.1 Address management	34
3.6.2 Network analysis, monitored port	34

4 PARAMETERIZATION

36

4.1 Installation of the INATnet parameterization	36
4.2 Initial Configuration of the S5-TCP/IP 100	37
4.2.1 Setting Parameters via IP or H138	
4.2.2 Serial Parameterization	40
4.2.3 Offline	41
4.3. Setting up connection	43
4.3.1 PLC parameter settings	44
4.3.3 TCP/IP Parameter Settings	46
4.3.4 H1 Parameter Settings	47
4.4 FTP Connection	49
4.5 Standard connections	51
4.6 Modbus table	51

5 MENU FUNCTIONS

54

5.1 Station list	54
5.1.1 Station not found	54
5.1.2 OK	55
5.1.3 Cancel	55
5.1.4 New	55
5.1.5 Edit	55
5.1.6 Delete	55
5.1.7 Print	55
5.1.8 Help	55
5.1.9 Internet	55
5.1.10 Timeout	56
5.2 Connection window	56
5.2.1 Functions via right mouse button	56
5.2.2 Menu File	58
5.2.3 Menu Connection	59
5.2.4 Menu Diagnosis	60
5.2.5 Menu Station	63
5.2.6 Menu Extras	64
5.2.7 Menu Help	72

APPENDIX

74

Special TCP/IP Settings	74
--------------------------------	-----------

CHAPTER 1:



GENERAL



1 GENERAL

1.1 Scope of supply

Before getting started with INAT S5-TCP/IP 100, check the following list of components contained in the S5-TCP/IP 100 package.

S5-TCP/IP 100	
CDROM with INATnet Parameterization INAT Demo software INAT Manuals	

1.2 Specifications

Ethernet interfaces:	4 port switch: <ul style="list-style-type: none"> • 10 / 100 Mbps • full duplex / half duplex - 10Base-T/100Base-TX • Auto-negotiation • RJ45 • Link LED and Activity LED for each single port
PG interface:	TTY, 15 pin D-sub female with locking post
Compact Flash Slot:	Type I or II (standard) to save the configuration, hot plug capacity
Supply voltage:	DC +5V via S5 backplane
Power input:	max. 3A
Conditions: <i>Operating temperature:</i> <i>Storing / transport temperature:</i> <i>Relative humidity:</i>	0 to 60°C -20 to 70°C max. 95%
Card format:	Double Europe
Measures [L x H x D in mm]:	255 x 20,3 x 174
Weight:	350g
Required space:	1 slot; for use in AG-115 adaptation casing required
Configuration tool:	INATnet Parameterization
Other:	Protected configuration in case of failure in power supply

1.3 Compatibility with S5-TCP/IP

S5-TCP/IP and S5-TCP/IP 100 are compatible. Existing parameterization data can be used when a change is made.

Save the stations and connection parameters of your „old“ S5 CP with the INATnet parameterization software (File > Store Data to File) as .NetParameter file. Load this file to your new CP with the INATnet parameterization software (File > Load File to Device). As a result of different card slots, a transfer via memory card is not possible.

CHAPTER 2: HARDWARE



2 HARDWARE

2.1 Overview

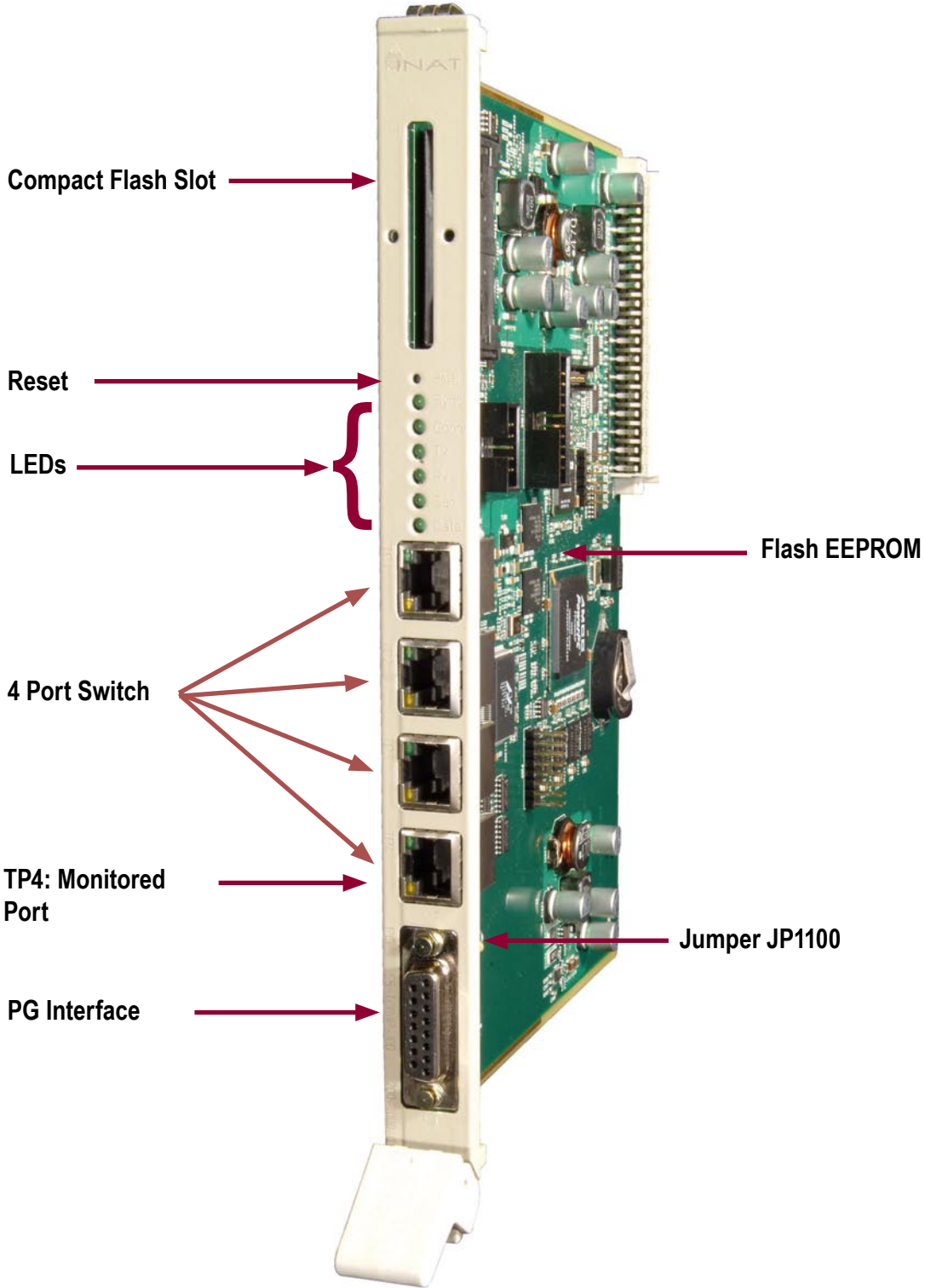

2.1.1 Compact Flash

The Compact Flash Slot on the front panel can be used for Compact Cards Type I or II. The pin assignment is compatible with Compact Flash Standard. The Compact Flash Slot is Hot Plug capable. You use a CF Card:

- ⇒ as additional backup for parameter data of the S5-TCP/IP 100 (station parameters, configured connections etc.), that is configured with INATnet parameterization.
- ⇒ to transfer saved parameter data from a CF Card to the FLASH-EEPROM of the S5-TCP/IP 100. When the CF Card is plugged and voltage is connected, data is transferred.

Only **cards for 3,3 V Supply voltage** without DMA Mode are supported. The CF Card should be DOS formatted. You can get such a card from INAT GmbH.

When using the Compact Flash Card, it may happen that the CP stops in a undefined status. If this happens, reset the CP.

2.1.2 Reset

The reset button causes a reset of the S5-TCP/IP 100. Connections and system settings are not changed. To avoid a reset by mistake, the reset button is counter-sunk and can only be pressed with a small nail. It may happen that the CPU of the PLC stops when using the reset button.

2.1.3 LEDs

There are 5 LEDs on the front panel to display the operating status of the CP. The RJ45 interfaces are equipped with 2 additional LEDs to display the communication status:

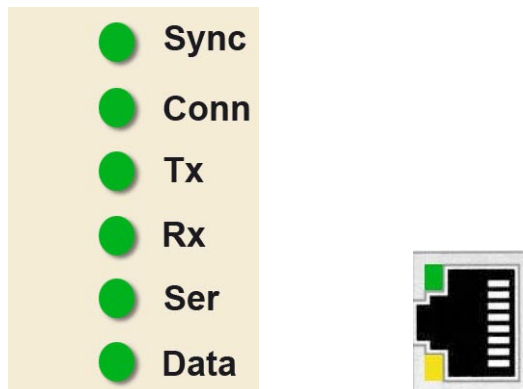

The LEDs have the following meaning:

LED	Meaning
Sync	illuminated: CP is synchronized
Conn	illuminated: the connection is established
Tx	blinking: CP is sending data via Ethernet
Rx	blinking: CP is receiving data via Ethernet
Ser	illuminated: the serial interface is used
Data	illuminated: PLC and CP are transferring data (with slow communication, LED may blink)

2.1.4 Switch

The S5-TCP/IP 100 is equipped with a 4 port switch. With it, a small local network may be set up or several Ethernet devices may be connected. Port 4 is a so called „monitored port“. All frames, that are transferred via port 4, are sent, as a copy to the internal NetSpector Record and can be analyzed with INAT NetSpector. The interfaces are configured as follows:

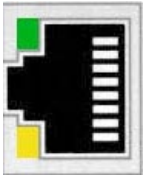

Pin	Signal	Function
1	TD+	Transmit Data +
2	TD-	Transmit Data -
3	RD+	Receive Data +
4	----	<i>not used</i>
5	----	<i>not used</i>
6	RD-	Receive Data -
7	----	<i>not used</i>
8	----	<i>not used</i>

Each port has a Link LED and a Activity LED:

LED	Meaning
Activity LED (green)	blinking: the port receives or sends data via Ethernet
Link LED (yellow)	illuminated: a TP cable is connected to this port

The ports support auto-negotiation and Auto MDI / MDI-X auto-crossing. More information about the functionality of the switch can be found in [chapter 3.6](#).

2.1.5 PG interface (AS511 interface)

The PG interface is a 15 pin socket connector for connecting a programming device or the S5-CP / AG-cable.

Name / Description	Pin
GND	15
+5V ¹	14
S2 (Power source 2)	13
GND	12
S1 (Power source 1)	11
GND	10
RXD+ (Receive Data Signal)	9

¹ Power supply +5V for external transceiver. Configurable via jumper (see [Chapter 2.1.6 jumper 1100](#)). Default: OFF

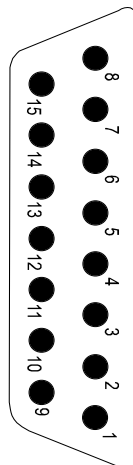

Pin	Name / Description
8	GND
7	TXD- (Transmit Data Back Signal)
6	TXD+3 (Transmit Data Signal)
5	GND
4	---
3	+5V (Power supply +5V for external transceiver)
2	RXD- (Receive Data Back Signal)
1	GND

The wiring and programming of the PG interface determines which signals will be used. The following wiring has proven successful when using the PG functions with the S5-TCP/IP 100 and the PLC.

PLC	Pin No.	Pin No.	S5-TCP/IP 100
Signal			Signal
Mext (ext. ground, shield)	1	1	Mext (ext. ground, shield)
TTY IN (current output) <i>jumpered</i>	2	2	TTY IN (current output) <i>jumpered</i>
Masse (interne Masse)	12	12	Masse (interne Masse)
TTY OUT (current input) <i>jumpered</i>	6	6	TTY OUT (current input) <i>jumpered</i>
20mA current source of sender	11	11	20mA current source of sender
TTY OUT (current output)	7	9	TTY IN (current input)
Mext (external ground)	8	8	Mext (external ground)
TTY IN (current input)	9	7	TTY OUT (current output)

2.1.6 Jumper 1100

As default there is no voltage at pin 14 of the PG interface. The power supply can be configured with a jumper to the pins with the identifier „JP1100“.

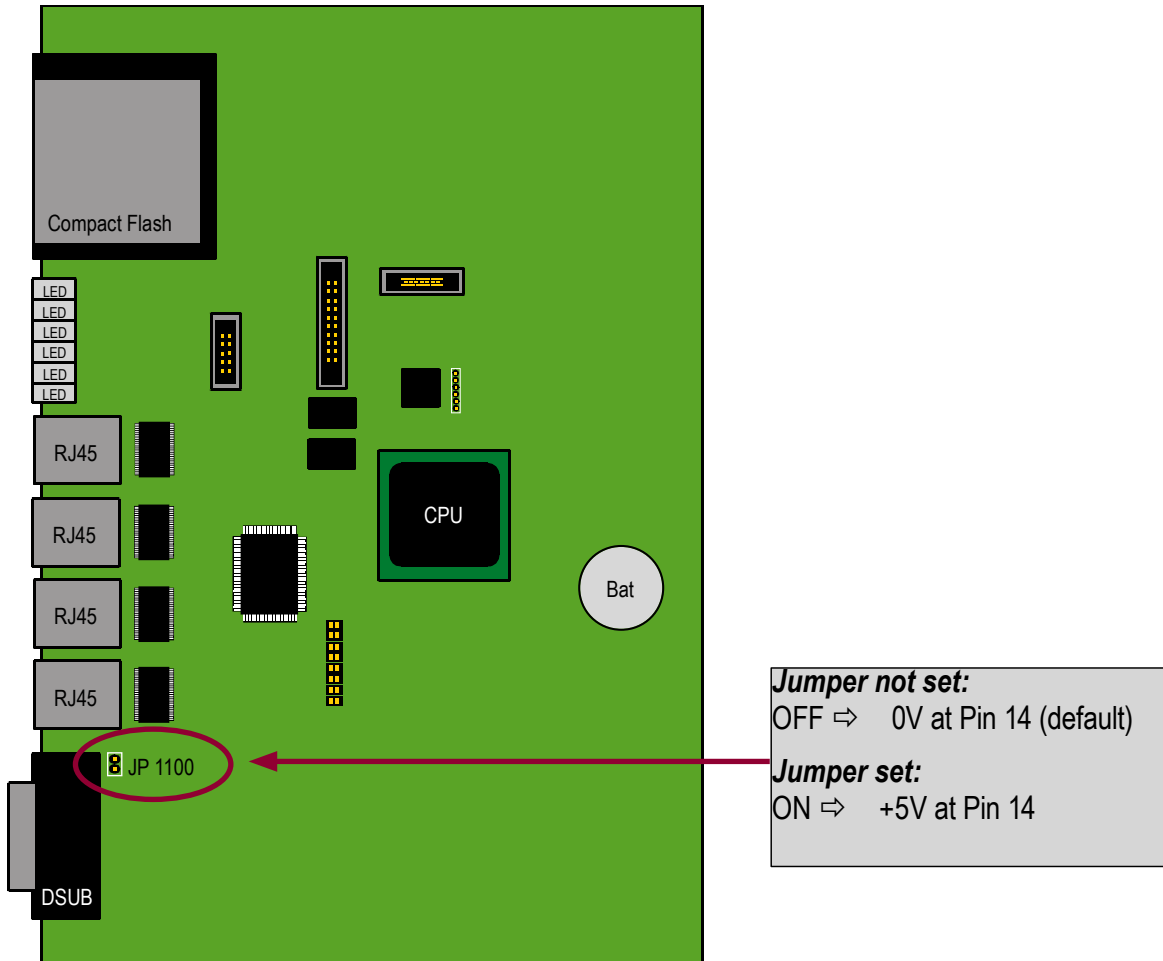

2.2 Installation

For installation of the S5-TCP/IP 100 follow these steps:

Step 1:	Installing the S5-TCP/IP 100 in the PLC rack
Step 2:	Connecting the CP to the Ethernet network
Step 3:	Connecting the CP to PC/PG
Step 4:	Connecting the Swing Cable

2.2.1 Installing the S5-TCP/IP 100 in the PLC rack

The S5-TCP/IP 100 can be installed in any PLC slot of the AG 115U, 135U, 150U and 155U that is allowed for CP operation. For further information about PLC slots, please refer to the PLC manual (in AG 115 an adaptation casing is required).

- ⇒ when plugging in the S5-TCP/IP 100 please switch off the power supply
- ⇒ Hang the S5-TCP/IP 100 in the rack
- ⇒ Tighten the CP

NOTE

For both plugging and pulling the S5-TCP/IP 100 the power supply must be turned off!

2.2.2 Connecting the CP to Ethernet and connecting further Ethernet components

The S5-TCP/IP 100 has four TP ports, which can be used for the connection of the module to the Ethernet. Connect the CP via one of the four ports to Ethernet.

If desired further components may be connected to Ethernet via one of the TP ports (e.g. programming devices /PC/PLC). An auto-crossing mechanism is integrated in the switch so that a connection to other stations is possible with a standard cable.

2.2.3 Connecting the CP to PC/PG

A connection between the S5-TCP/IP 100 and a PG/PC is required for:

- ⇒ Online Parameterization
- ⇒ Serial Parameterization
- ⇒ Transfer of a parameter file from the PG/PC to CP and vice versa
- ⇒ Diagnosis and test functions
- ⇒ Programming the PLC

The connection between PC/PG and CP can be made directly over the serial interface or indirectly over a bus path.

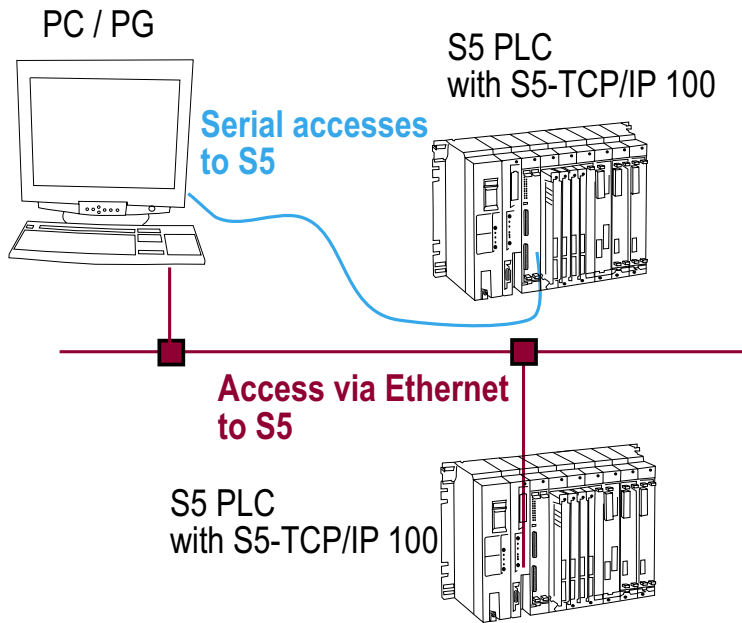

In the illustration the upper of the two controls is connected by a serial connection cable to the PG/PC, while the lower PLC is accessed via Ethernet (TCP/IP and/or H1).

A serial RS232/TTY cable is not included in the scope of delivery. Please order it separately with the order number 700-1500-05 (RS232, 9pin D-sub female - TTY, 15pin D-sub male).

2.2.4 Connecting the Swing Cable (PLC Cable S5-CP / PLC)

For programming the PLC via Ethernet a connection between CP and PLC is required. Therefore a cable S5-CP / PLC is used. PLC cable S5-CP / PLC (TTY, 15pin D-sub male - TTY, 15pin D-sub male) is not included in the scope of delivery of the S5-TCP/IP 100. Please order it separately with the order number 700-1700-01.

Additional start-up information covers the basic configuration of the S5-TCP/IP 100 as well as the connecting parameterization. Both are accomplished with the INATnet Parameterization software and is described in detail in chapter 4.

CHAPTER 3: FUNCTION



3 FUNCTION OF THE S5-TCP/IP 100

The CPU of the PLC and the S5-TCP/IP-100 exchange data messages via the periphery bus. All modules connected to the S5 are electrically connected via that bus. The S5-TCP/IP-100 supports page frame addressing. That means, that the data exchange with the CPU is handled via the so-called „page frame“. The page frame is an address space that may be used by 256 modules simultaneously. The dual port RAM of the CP lies in this address space. Since the modules use the addresses together, the module that shall be accessed by the application program must be previously chosen. That is made with the interface number. Communication is triggered by the application program on the S5 PLC using handling blocks (HDBs).

3.1.1 Handling blocks

Handling blocks (HDB) are standard function blocks that allow the data exchange between modules, which support page frame addressing. They control the communication between the central processor and the communications processor in the PLC. To send and receive data, the handling blocks SEND and RECEIVE are used.

When there is a send job to be executed, the automation program supplies the SEND HDB with parameter values and transfers the send job via the dual-port RAM to the communications program of the CP. The communications program executes the send job and reports the status of the job back to the automation program.

When there is a receive job, the automation program supplies the RECEIVE HDB with parameter values and transfers the receive job via the dual-port RAM to the communications program of the CP. The communications program then executes the receive job and reports the status of the job back to the automation program.

The communications program receives the SEND and RECEIVE jobs from the PLC program via the dual port RAM. To allow these jobs to be passed on, the background communication must be activated. In this case the SEND-ALL handling block is called in the user program to trigger send jobs and the RECEIVE ALL handling block to trigger receive jobs.

	Handling blocks	
	S5 135U / 150U / 155U	S5 115U
Function		
SYNCHRON	FB 125	FB 249
SEND	FB 120	FB 244
RECEIVE	FB 121	FB 245
SEND ALL	FB 126 (A-NR = 0)	FB 244 (A-NR=0)
RECEIVE ALL	FB 127 (A-NR = 0)	FB 245 (A-NR=0)
FETCH	FB 122	FB 246
CONTROL	FB 123	FB 247

3.1.1.1 SYNCHRON

The SYNCHRON handling block is used to establish the synchronization between CP and PLC. Only after the synchronization data can be exchanged over this interface.

3.1.1.2 SEND

The SEND handling block is used to transfer a job (with or without the user data for transfer) to the CP.

=> Job types SEND direct and WRITE active

3.1.1.3 SEND-ALL

The SEND-ALL block is used for background communication, which is responsible for the complete delivery of the data of the CPU to the CP.

3.1.1.4 RECEIVE

The RECEIVE handling block is used to accept a job (with or without the user data for transfer) from the CP.

=> Job type RECEIVE direct

3.1.1.5 RECEIVE-ALL

The RECEIVE-ALL block is used for so-called „background communication“, which is responsible for the complete takeover of the data of the CPU to the CP.

3.1.1.6 FETCH

The FETCH handling block is used to fetch data. It is used for the job type FETCH.

3.1.1.7 CONTROL

The CONTROL handling block is used to query the status of a job.

3.1.2 Supplying Parameters for handling blocks (HDBs)

The HDBs must be supplied with the following interface parameters:

```

SEND

L   KH 0000
T   MW 96
O   M 255.0
ON  M 255.0
SPA FB 244
NAME: SEND
SSNR: KY 0,0
A-NR: KY 0,50
ANZW: MW 96
QTYP: KC DB
DBNR: KY 0,10
QANF: KF +0
QLAE: KF +600
PAFE: MB 98
    
```

```

RECEIVE

L   KH 0000
T   MW 96
O   M 255.0
ON  M 255.0
SPA FB 245
NAME: RECEIVE
SSNR: KY 0,0
A-NR: KY 0,55
ANZW: MW 96
ZTYP: KC DB
DBNR: KY 0,141
ZANF: KF +0
ZLAE: KF +600
PAFE: MB 98
    
```

SSNR	interface number (=page frame base address + job offset)
A-NR	job number, number of the activated job
ANZW	status word
QTYP	type of data source
ZTYP	type of data destination
DBNR	data block number
QANF	relative start address within the type
ZANF	relative start address within the type
QLAE	number of source data
ZLAE	number of destination data
PAFE	parameter assignment error byte

3.1.3 Functionality of handling blocks

CPU and CP communicate via the dual port RAM (DPRAM). In order that several CPs are able to exchange data with the CPU via this memory, the DPRAM is divided into pages. Each page is numbered. In the handling block of the PLC program, the interface number (SSNR) is used to address the S5-TCP/IP 100. It identifies the page frame base address of the S5-TCP/IP as well as the job offset.

With the initial configuration of the S5-TCP/IP it is assigned a page frame base address. Each connection parameterized with the INATnet software is assigned a job offset and a job number (A-NR). The S5-TCP/IP 100 identifies the individual job based on the combination of A-NR and SSNR. This combination must be unique.

3.1.3.1 Send job

- For a send job the automation program supplies the SEND handling block with parameter values.
- The interface number (SSNNR) identifies the page frame basic address of the CP and the transfer area (job offset) in dual port RAM (DPRAM) for the exchange of messages between S5 PLC and S5-TCP/IP 100

- The S5-TCP/IP 100 makes a data buffer available and transfers the all sending data into the data buffer via background communication (SEND ALL).
- The S5-TCP/IP 100 identifies the job based on the A-NR. This number enables a connection parameterized in the S5-TCP/IP 100. This connection contains the connection parameters.
- With the connection parameters the S5-TCP/IP 100 creates a PDU. When the receive enable is set on the partner station, the PDU is transferred via the network to the partner station.
- After the PDU has been received in the partner station, the S5-TCP/IP 100 receives an acknowledgement via the network and transfers the status of the send job to the assigned status word.

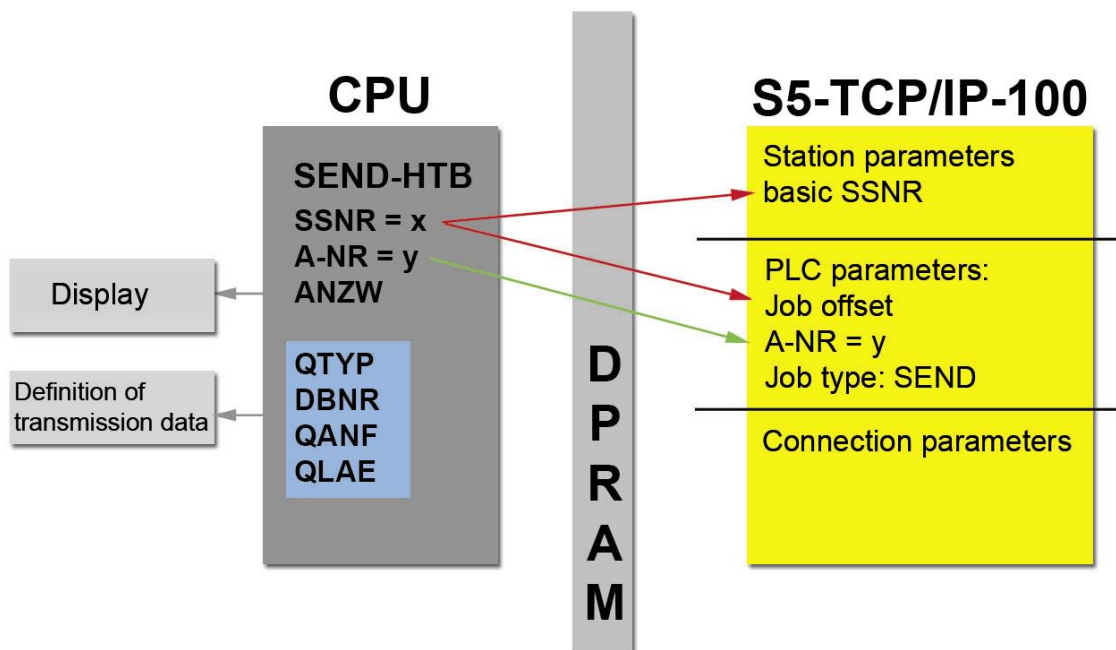

3.1.3.2 Receive job

- For a receive job the automation program supplies the RECEIVE handling block with parameter values.
- The interface number (SSNNR) identifies the page frame basic address of the CP and the transfer area (job offset) in dual port RAM (DPRAM) for the exchange of messages between S5 PLC and S5-TCP/IP 100
- The S5-TCP/IP 100 makes a data buffer available and sends a receive enable to the partner station for this connection.
- The partner station sends the PDU for this connection. The S5-TCP/IP 100 receives the PDU and extracts the data to be received. With the help of the background communication (RECEIVE ALL) the communications program transfers the data into the data buffer of CPU.
- The receive job with the actualization of the status word is terminated.

3.2 Communications S5-TCP/IP 100 with other Ethernet stations

For communication with other Ethernet stations transport connections are required. When sending data the S5-TCP/IP 100 packs the data in one or more protocol data units (PDU). This PDU(s) is (are) transferred via the network to the partner station. The S5-TCP/IP 100 receives PDUs addressed to it from the Ethernet and decodes these PDUs so that they can be understood by the application program of the S5 PLC.

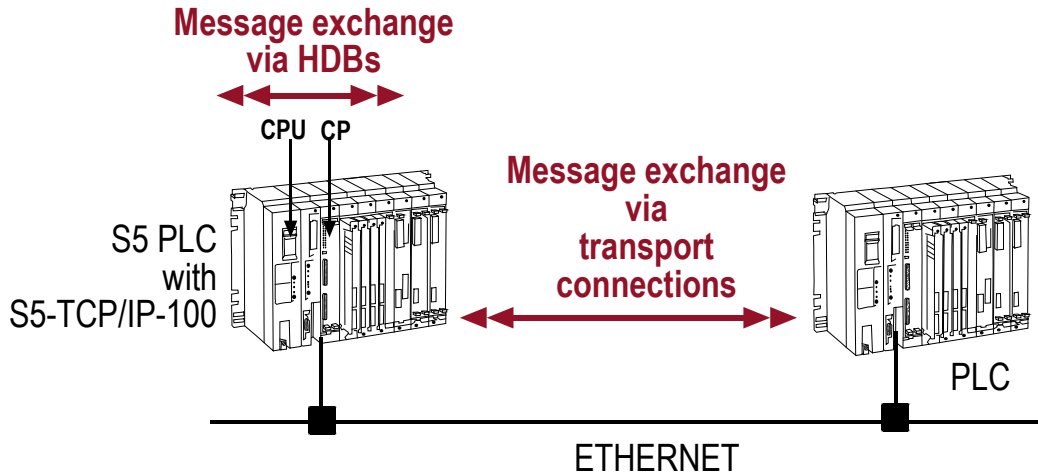

3.3 Job types

The S5-TCP/IP 100 supports the following job types:

<i>Job types</i>	
Send direct	Receive direct
Fetch activ	Fetch passive
Write activ	Write passive
Fetch on Event passive	

3.3.1 SEND / RECEIVE

SEND / RECEIVE is a program controlled communication to any other station (PC, S5, S7...). The station, that handles the SEND job sends data to the other station. The other station receives this data with a RECEIVE job. SEND and RECEIVE build together a job pair.

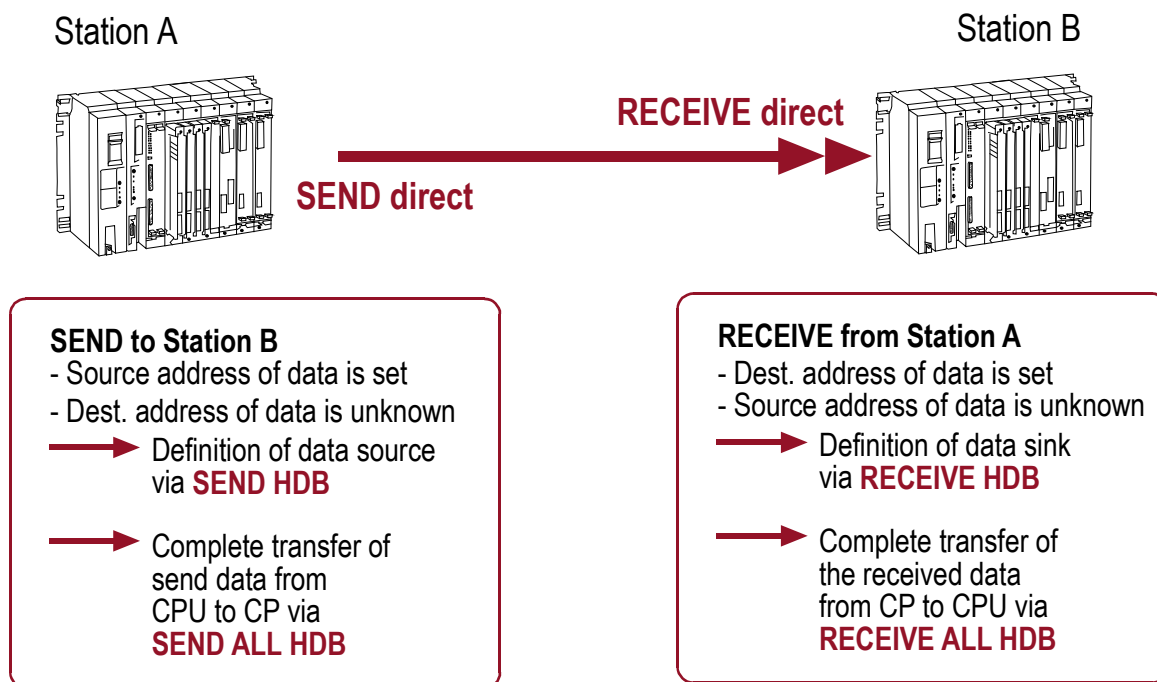

In the application program of the sending station is defined, when and which data shall be send. In the application program of the receiving station is defined how to interpret the data and where to save it.

SEND / RECEIVE is layer 4 communications that can be handled via H1, TCP, UDP or RFC1006.

3.3.2 WRITE active / WRITE passive

The WRITE function allows a data record to be transferred from a PLC (Write active) to a remote device (Write passive). In contrast to SEND/RECEIVE, with WRITE, the parameter data record that defines the data sink (data destination) is also transmitted. The active end of the WRITE service can therefore force data on to the passive end.



WRITE active

- Source address of data is set
- Dest. address of data is unknown

- ➔ Definition of data source via **SEND-HDB**
- ➔ Definition of data sink via **SEND-HDB**
- ➔ Complete transfer of send data from CPU to CP via **SEND ALL-HDB**

Write passive

- Dest. address of data is set

- ➔ Complete transfer of received data from CP to CPU via **RECEIVE ALL-HDB**

In contrast to a RECEIVE job, the receiver initially does not know, how to interpret the data or where to save it. This information has to be transmitted together with the raw data.

WRITE is layer 7 communications that can be handled via H1, TCP, UDP or RFC1006. In addition to the transport protocols, application protocols are required that control additional handling of the data. Such application protocols are S7, S5 or Modbus on TCP.

3.3.3 FETCH active / FETCH passive

The FETCH function allows a data record to be fetched. The receiving station (Fetch active) is the active part, while the sending station (Fetch passive) is passive and allows the active station to fetch data. In the application program of the receiving station is defined which data shall be fetched and where it shall be saved in the local station.

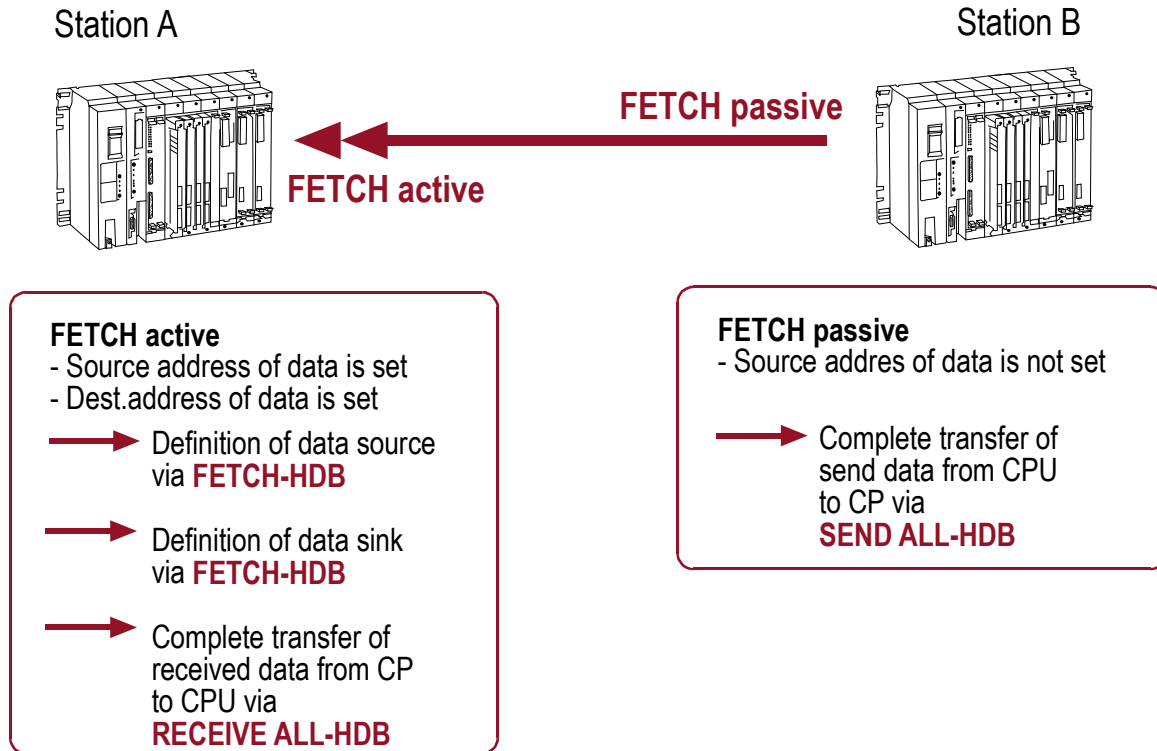

In contrast to a SEND job, the sender does initially not know, which data shall be send. This information has to be transmitted.

FETCH is layer 7 communication that can be handled via H1, TCP, UDP or RFC1006. In addition to the transport protocols, application protocols are required, that control additional handling of the data. Such application protocols are S7, S5 or Modbus on TCP.

3.3.4 FETCH on EVENT passive

The Fetch on Event function allows the FETCH on Event data to be read from a remote station (passive end). The active end requests data and the passive end provides this data. The parameter data record that describes the data source is also transmitted. In contrast to the „normal“ Fetch function, with Fetch on Event data, is only transferred in case of an event (when the value of the requested data has changed). This check is made by the communications processor.

With „normal“ Fetch function, the requested data is sent always - no matter if it has changed or not. Fetch on Event functionality can thereby reduce network traffic.



FETCH active

- Source address of data is known
- Dest. address of data is set
- ➔ Definition of data source via **FETCH-HDB**
- ➔ Definition of data sink via **FETCH-HDB**
- ➔ Complete transfer of received data from CP to CPU via **RECEIVE ALL-HDB**

FETCH on EVENT passive

- Source address of data is not set
- ➔ Complete transfer of send data from CPU to CP via **SEND ALL-HDB**

Fetch on Event Passive simple	Fetch on Event Passive repeated / automatic
<p>It is based on the S5 standard protocol.</p> <p>Event-controlled inquiries of systems, which support the S5 protocol, can be made (example: CP 1430). The partner station is parameterized like with a „normal“ Fetch active job.</p>	<p>It is based on the Fetch on Event protocol.</p> <p>Event-controlled inquiries of systems, which support the Fetch on Event protocol, can be made (example: INAT OPC Server).</p>

3.4 Connections

Different connection parameters are required depending on the application protocol that is used to transport over the network.

3.4.1 H1 connection

H1 is an ISO 8073 class 4 protocol which is arranged on the layer 4 of OSI reference model. ISO 8073 is an ISO standard that describes connection-oriented transport protocols. A connection-oriented protocol exchanges control information with the remote system to verify that it is ready to receive data before sending it. When the handshaking is successful, the systems are said to have established a connection.

3.4.1.1 Connection establishment

The station with an active connection established sends a connection request to the passive station. If the passive station accepts the inquiry, it sends back a connection established confirmation. The active station then sends a confirmation to the passive station and the connection is established. Both stations are now ready for data transfer.

3.4.1.2 Progress of the H1 connection

The data transfer with an ISO (H1) transport connection is characterized by acknowledging data blocks.

- After the sending station transfers a data block, it expects an acknowledgment from the receiver within a certain time.
- The receiver sends an acknowledgment to the sender as soon as a data block was received.
- Only after the sender receives this acknowledgment will it sends new data blocks.
- If the acknowledgment is not received within the defined time, the data block is considered lost or not sent and the sender transfers the data block again.

3.4.1.3 Closing the H1 connection

A connection is closed when one of the two stations asks for a connection clearing. The partner confirms the request and confirms the connection clearing to have taken place. The connection is considered as closed.

3.4.1.4 Required parameters for H1 connections

H1 connections use MAC addresses and TSAPs for the unique connection from the sender to the receiver.

Address information in H1 connections	
Station access	MAC Addresses
Application access	TSAPs

MAC address

Ethernet components targeted by messages need an unambiguous physical address, the MAC address. The MAC address and destination MAC address are part of the Source Field (the Destination Field) of the MAC header of an Ethernet frame. With the MAC address a machine is unambiguously identified on the network. In ISO (H1) networks the MAC addresses uniquely identify the access to the stations.

Since the addressing of stations in H1 networks is made exclusively by the MAC address, communication is limited to an individual LAN.

Stations outside of its own network may not be reached with the protocols of Layers 1 and 2. H1 is not able to route.

The MAC address ensures that data reaches the required destination station. TSAPs ensure that the data reached the required application within the destination station.

TSAPs

TSAPs (transport service ACCESS POINTs) are connection end points that are used in H1 connections to enable the data transfer between 2 applications. For each connection between the communication partners one pair of TSAPs is used:

local TSAP	defines the connection end point of the local system
remote TSAP	defines the connection end point of the partner station

In order to establish the connection, TSAPs must correspond crosswise i.e. „local TSAP“ of communication partner A must correspond to the „remote TSAP“ of communication partner B. The „remote TSAP“ of station A must correspond to „local TSAP“ of station B.

local TSAP (Station A) = remote TSAP (Station B)
remote TSAP (Station A) = local TSAP (Station B)

TSAPs have a minimum length of 2 bytes and a maximum length of 16 bytes. An H1 connection is clearly described by the combination of TSAPs and MAC addresses.

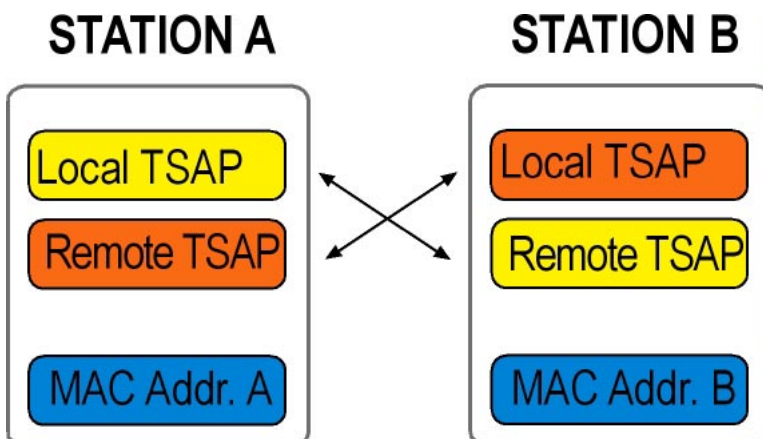

3.4.2 TCP/IP Connection

IP

The IP (Internet protocol) provides the communication to individual global addresses of computers. IP uses IP addresses. No circuit setup is needed, IP is a connectionless protocol.

TCP

Using TCP applications on networked hosts can create connections to one another and exchange streams of data. The protocol guarantees a reliable and orderly delivery of data from sender to receiver. While IP provides the transport between 2 stations, TCP provides the data transfer between 2 applications. The applications of the upper layers are addressed with port numbers.

UDP

UDP provides application programs direct access to a datagram delivery service such as the delivery service that IP provides. This allows applications to exchange messages over the network with a minimum of protocol overhead. UDP is unreliable, connectionless datagram protocol. There are no techniques in the protocol for verifying that the data reached the other end of the network correctly. UDP uses 16-bit Source Port and Destination Port numbers in word 1 of the message header, to deliver data to the correct applications process.

3.4.2.1 TCP connection establishment

The type of handshake used by TCP is called a three-way handshake because three segments are exchanged. After this exchange, TCP has positive evidence that the remote TCP is alive and ready to receive data. As soon as the connection is established, data can be transferred.

3.4.2.2 Procedure of the TCP connection

The data transfer with a TCP transport connection is characterized by acknowledging the TCP segments. This procedure is called **Positive Acknowledgment with Retransmission**:

- After sending the TCP segment the sender keeps a copy of the sent packets and expects an acknowledgment of the receiver within a certain time. There to the sender starts a timer.
- If a TCP segment is received, the receiver sends an acknowledgment of receipt to the sender.
- Only after the receipt of the acknowledgment can new TCP segments be dispatched.
- If the timer runs out the sender assumes its packet was lost and repeats the transmission.

TCP segments are transferred in IP datagrams. These datagrams can be transported over different ways. The individual TCP segments can arrive at the receiver in different sequence than they were sent.

TCP must be able to reorganize the individual TCP segments to the same sequence as they were sent.

3.4.2.3 TCP connection termination

When an endpoint wishes to cancel the connection it sends a FIN and the communication partner replies with a FIN & ACK. Station 1 replies with an ACK.

3.4.2.4 Required parameters for TCP connections

TCP connections use IP addresses and ports for the unique route from the sender to the receiver.

IP address	Data exchange between 2 stations
Port	Data exchange between 2 applications

IP address

In a TCP/IP-based network each station or each device receives a unique IP address. In the Source Address Field and Destination Address Field of the IP header, the source IP address and the IP address of the destination station are used. Only with this additional addressing can stations that are outside the own network can be addressed. The MAC header alone is not sufficient for it. IP addresses have a length of 32 bits, which are divided in four groups of numbers. The groups are separated by a dot (example of an IP address: 192.0.9.4).

Port number

After IP passes incoming data to the transport protocol, the transport protocol passes the data to the correct application process. Application processes are identified by port numbers, which are 16-bit values. The Source Port Number which identifies the process that sent the data and the Destination Port Number which identifies the process that is to receive the data are contained in the first header word of each TCP segment and UDP packet. Port numbers below 256 are reserved for „well-known-services“ (like FTP and TELNET) and are defined in the RFCs. Ports numbered from 256 to 1023 are used for other specific services.

The combination of an IP address and a port number is called socket. A socket uniquely identifies a single network process within the entire Internet.

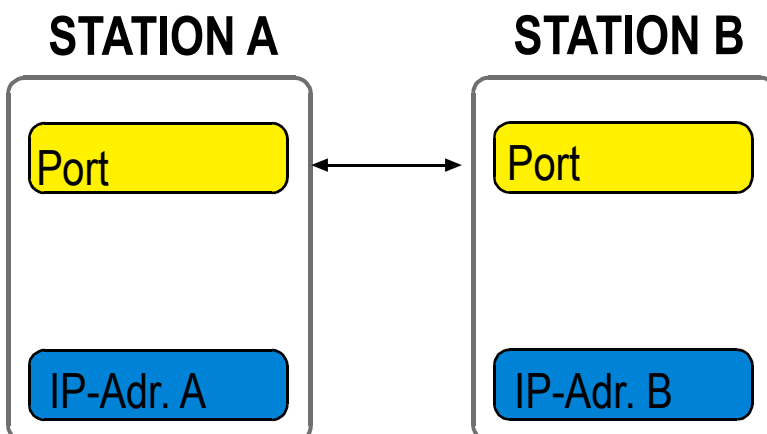

3.4.3 Difference: TCP/IP - H1

TCP is a stream-oriented protocol. It is permitted to send almost any length IP packet it chooses. If two messages were passed to a TCP/IP stack, the TCP/IP stack may choose to put both messages in one Ethernet frame. Alternatively it may choose to place half of the first message in the first Ethernet frame and all the rest in the next Ethernet frame. There is no EOM recognition.

H1 (ISO) is a message-oriented protocol. There is EOM recognition. Messages arrive at the destination exactly in the same form they have been sent from the sender. Input block and Output block are identical.

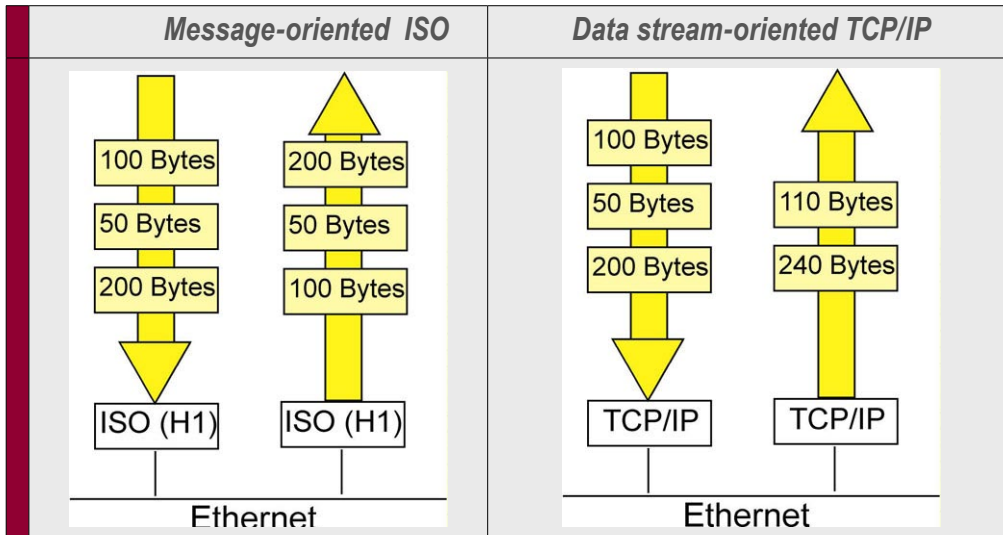

In automation technology the block oriented transmission is common. To give TCP a message structure, there are two possibilities:

TCP with a message structure
ISO on TCP (RFC1006)
INAT PLC Header

3.4.4 RFC1006

RFC1006 (ISO Transport Service on the top of the TCP) specifies how to carry an ISO transport protocol on top of the TCP/IP protocol and is used for standard connections in the Simatic environment. The services of the ISO transport protocol are transferred „on the back“ of TCP/IP. The transport connection is handled via TCP/IP, where port 102 is used.

To address stations, IP addresses are used; to address applications, TSAPs are used. For each connection a local and a remote TSAP is defined.

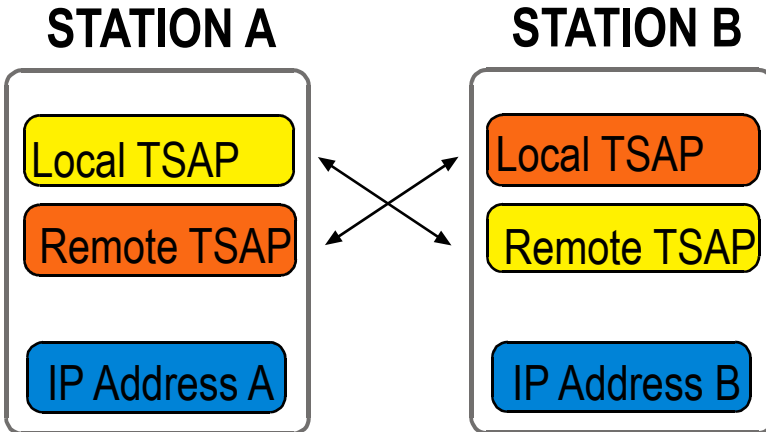

3.4.5 INAT PLC Header

With the PLC Header data transfer to the PLC is optimized. The header provides a frame counter, frame length information and the possibility to send acknowledgments. All INAT components support the INAT PLC header. The header is 8 bytes long:

Byte	Value	Function
0	'M' (0x4d)	Signature for Recognition
1	'K' (0x4b)	Signature for Recognition
2	Datalen LSB or MSB (WMK_BIG_ENDIAN)	Data Length
3	Datalen LSB or MSB (WMK_BIG_ENDIAN)	Data Length
4	WMK_BLOCKFLAG WMK_BIG_ENDIAN WMK_BIW_SEQ	Bit field for transmission state
5	Must be 0	Reserved for add-ons
6	Sequece No. LSB or MSB (WMK_BIG_SEQ)	Sequence Number
7	Sequece No. LSB or MSB (WMK_BIG_SEQ)	Sequence Number

User Data

Field Datalen

In the field Datalen the length of the data is indicated. If DataLen is 0, a life data acknowledge (Life Data Ack) is involved and not user data. Data acknowledgement permits a form of connection monitoring in which the TCP/IP actually does not provide for a remote-communication frame. Since the standard times for connection monitoring correspond to those of the H1 protocol, the S5-TCP/IP system is compatible with H1 as seen from the PLC or PC.

Bit field for transmission state

In byte 4 special bits are set to receive specific transmission states:

<i>Bit Position</i>	<i>Symbolic name</i>	<i>Use</i>
0	WMK_BLOCKFLAG	0: the telegram is the last one in a block sequence 1: the telegram is not the last one in a block sequence. Other telegrams are transferred.
1	WMK_BIG_ENDIAN	Data length is indicated in Big Endian Format.
2	WMK_BIG_SEQ	Sequence number is indicated in Big Endian Format.

Field Sequence Number

Byte 6 and byte 7 represent a sequence number which has the value 0 when the connection is established and which is incremented by one each time user data is sent. This frame counter is used as an additional safety mechanism for the data transmission. When life data acks are sent, the sequence number is not incremented and DataLen is 0.

Connections Fetch and Write

During the jobs, Fetch and Write, the first 16 data bytes at the start of a job correspond to the SINEC AP header, which is inserted also to the communication over H1.

3.5 Nomenclature INAT – Siemens

Siemens uses a different nomenclature than INAT does for job types. If you want to configure a communication between INAT S5-TCP/IP 100 and the Siemens CP 1430 or CP 143, you must consider the different nomenclatures when defining job types.

INAT Type of job		Send Direct	Receive Direct	Fetch active	Fetch passive	Write active	Write passive
Standard handling block		SEND	RECEIVE	FETCH	RECEIVE ALL	SEND	SEND ALL
Required parameters on Siemens side	Job	Send	Receive	Fetch	Fetch	Send	Receive
	READ/WRITE	No	No	Yes	Yes	Yes	Yes
	Active / Passive	(Active)	(Passive)	Active	Passive	Active	Passive

3.6 Function of the Switch

The S5-TCP/IP 100 is equipped with integrated 4 port switch with the following functions:

- ⇒ **Autonegotiation:** Procedure by which the switch recognizes the speed (10 or 100 Mbps) and duplex mode (half duplex or full duplex) of the connected device. The switch then chooses the same transmission parameters. Autonegotiation function can not be turned off.
- ⇒ **Auto MDI/MDI-X; Autocrossing:** The port automatically determines the configuration of the port and the end point with which it is connected. It is not necessary to make a distinction between 1:1 or crossover ethernet copper cables

3.6.1 Address management

The switch is self-learning. It determines which station is connected to which port and what its MAC address is. When a station sends a data packet, the switch analyses the source address and enters it into a port-based address table. This way the switch gets an overview about the design of the network.

The destination address of the data packet is analyzed as well and is compared with the address table. The switch decides from which port to which other port the connection has to go. The data packet is then sent to the correct port and only to this one.

If a packet is sent to a new - up to now unknown MAC address, the switch transfers the packet to all ports (except the port, where the packet came from). The switch only learns the current „active“ MAC addresses. If a station is disconnected from the port and another station is connected to it, a new combination MAC address/ port must be learned. That is why the combinations are only valid for a defined time. Address entries that are not used for as while, are removed from the address table. This time is called „Aging Time“, and is 5 minutes with the S5-TCP/IP 100. Each port of the switch is equipped with a link LED and an activity LED for simple diagnosis.

3.6.2 Network analysis, monitored port

The S5-TCP/IP 100 has an integrated INAT NetSpector Record. NetSpector is a protocol analyzer for industrial networks that consists of an indication part (View) and a recording part (Record).

NetSpector Record inside the S5 CP automatically records the entire data traffic where the CP is involved and sends it - if required - to NetSpector View. Port 4 of the switch is a so-called „monitored port“. The entire data traffics that passes thru this port is re-directed to the integrated Record and can be visualized and analyzed with INAT NetSpector. The data traffic at ports 2 and 3 of the switch can not be captured.

CHAPTER 4:

PARAMETERIZATION



4 PARAMETERIZATION

4.1 Installation of the INATnet parameterization

With the INATnet parameterization software you can register the S5-TCP/IP 100 in the network and set up the parameters for your connections. The parameters edited here are loaded directly to the S5-TCP/IP 100 or are saved locally for later transmission to the S5-TCP/IP 100. With the parameter settings software you can monitor connections and make diagnostic checks.

For the parameterization of the S5-TCP/IP 100 you need a PC with installed INATnet parameterization software. PC and S5-TCP/IP 100 have to be connected directly or indirectly.

For installing the software follow these steps:

1. If you received the INATnet parameterization from the INAT website (Download Area), please refer to point 5. If you received the software on a CDROM, please refer to point 2.
2. Insert the CDROM „S5-TCP/IP 100“. If autostart is not activated in your PC, use start.exe or index.html. If autostart is activated, the following dialogue appears:



Installation: a list of the files to install the S5-TCP/IP 100

Software Overview: a downloadable overview with INAT software and manuals

Informative Literature: a downloadable overview with INAT informative literature

3. Select „Installation“. The following window appears:



4. Click inatnet.exe
5. Save the file in a directory of your choice
6. Run the .exe file
7. When the parameter setting software is installed, S5-TCP/IP 100 can be registered in the network

4.2 Initial Configuration of the S5-TCP/IP 100

With the basic configuration the S5-TCP/IP 100 receives all necessary station parameters so that it can be identified as a network user like name, page frame base address, IP address (n), subnet mask etc.

⇒ Start the parameter setting software. The start dialogue appears:

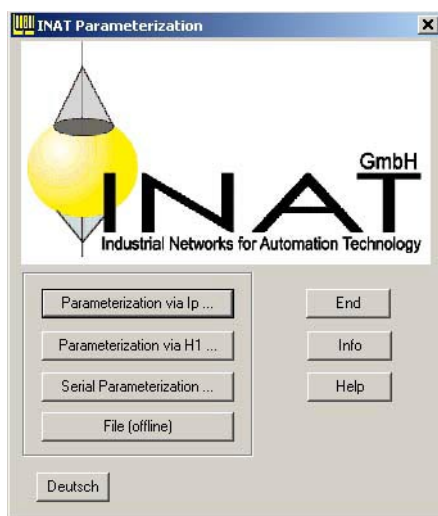

Four methods of setting the parameters are provided here: online (IP / H1), serial or offline. Whenever you start the parameter setting software, you are asked which method you want to use.

Set Parameters via IP / H1

For setting parameters via IP / H1 the S5-TCP/IP 100 has to be connected indirectly with the PC via the Ethernet network. This method of setting parameters permits you to set parameters for modules from any point of a TCP/IP or H1 network.

Set Parameters using a serial connection

To set parameters using a serial connection the PC and S5-TCP/IP 100 have to be connected directly via RS232/TTY converter cable. The parameter data are stored directly into the S5-TCP/IP 100. When the serial connection is used, the cable length is usually limited to a few meters (i.e., the module must have its parameters set on site).

File (offline)

With Offline the parameter files are stored locally in a file on the PC for later transmission to the S5-TCP/IP 100.

4.2.1 Setting Parameters via IP or H1

NOTE

When registering S5-TCP/IP 100 in the network (via IP or H1) the device has to be connected to the same LAN as the PC running the parameter setting software. Stations behind routers are not detected!

Select „Parameterization via IP“ or „Parameterization via H1“. The station list appears. All stations which are currently available online on the network are indicated. The new S5-TCP/IP 100 is indicated with its MAC address.

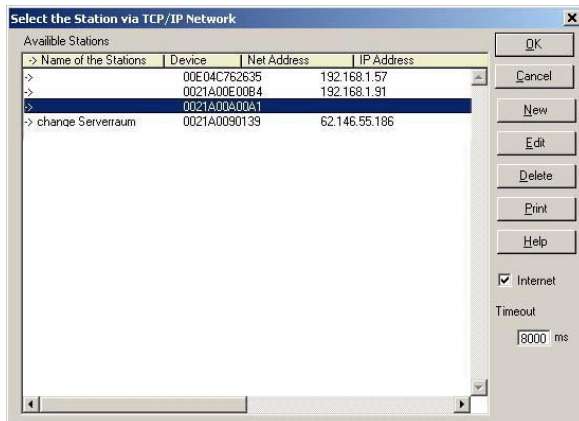

NOTE

All stations with „0021A0“ at the beginning of the MAC address are INAT components.

- Mark the S5-TCP/IP 100 station and click the button „OK“.
- The window to enter the station parameters appears.

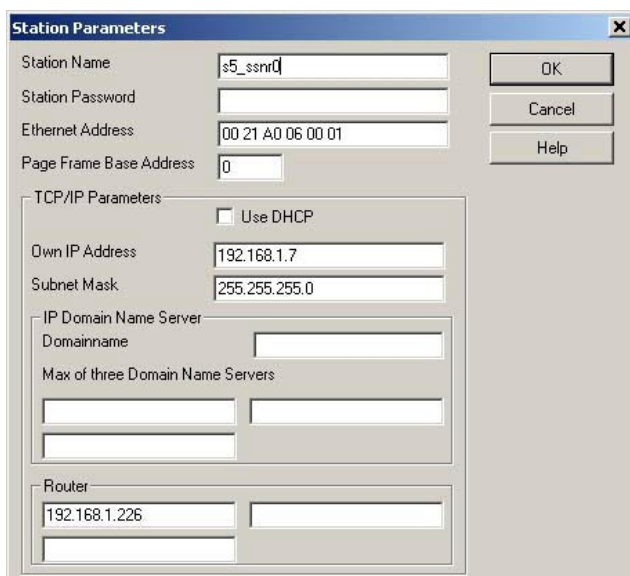

4.2.1.1 Station parameter settings

Station name

Each station can be assigned a name. This name is used to identify the station. Remember that each station name within a network must be unambiguous.

Station password

The station password protects the parameters in the station. If a password is set, this password is required whenever you try to edit the parameters. This applies only with online parameterization.

Ethernet address

Each station in an Ethernet network has an unambiguous station address. This address is stored on the network interface card and is used to identify the station in the network. INAT components always begin with the MAC address 0021A0.

Page frame base address

It determines the starting point of the 4 page frames imaged in the memory area of the controller. The page frame base address must be a number divisible by 8 (0, 8, 16...). When you set the base address, make sure it is unique in the S5 if you are using more than one CP.

TCP/IP Parameters

TCP/IP Parameters are required, when S5-TCP/IP 100 is used in a TCP/IP network. If „only“ H1 is used, these parameters are not required.

Use DHCP

If there is a DHCP Server configured in your LAN that can provide IP addresses from a pool of IP addresses, activate the button DHCP.

IP Address

The IP address defines the logical network address in TCP/IP networks. This address is indicated as a „sender“ address as well as „receiver address“ in data packets that are transferred with the IP protocol. So that there is always a clear package receiver, each user needs his unambiguous address.

Subnet mask

The IP Subnet Mask determines which station requests may pass to the active network. Addresses, which can be different in their masked part, are sent to the routers. If no router is parameterized the Subnet mask has no meaning.

IP Domain Name Server

Domain name

The domain name can be used to address a maximum of three Domain Name Servers in the network.

Max. of three Domain Name Server

The IP domain name server converts the symbolic Internet names into station addresses. Up to three domain names can be used.

Router

A router is used when an address cannot be located on the local network. Enter the address of the Routers here.

NOTE

Ask your system administrator for your IP address, subnet mask, gateway etc.

- Confirm your entries with „OK“. The station window appears again. The station is now indicated with Name, MAC address and IP address (if entries have been made)

4.2.2 Serial Parameterization

- Select „Serial Parameterization“.

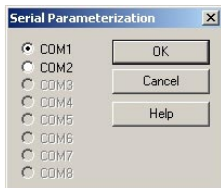

- Select the COM port of your PC, where the cable is plugged for connection with the S5-TCP/IP 100. If the connection is established the empty connection list appears. If the connection can not be established, a warning notice appears

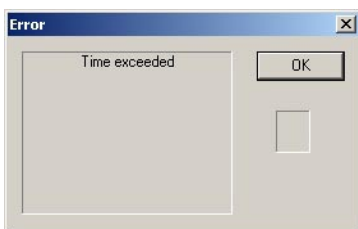

Possible causes:

- The connection cable may not be plugged in
 - The connection cable is allocated incorrectly
 - The interface card on your PC is defective
 - The interface on your PC is being used for another task
-

- Select Station > Current Station
- The window „Station parameter Settings“ appears

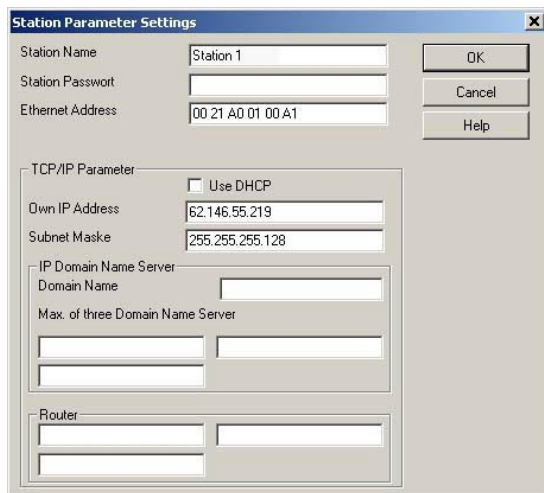

- Please refer to [chapter 4.2.1.1 station parameter settings](#) to learn what entries can be made here.
- Confirm your entries with „OK“. The station window appears. The station is now indicated with Name, MAC address and IP address (if entries have been made).
- The registration is complete. Connections can be parameterized now.

4.2.3 Offline

- Start the parameter setting software and select „File (Offline)“.
- The window „Reading the connection file“ appears. Here you can open an existing parameter file or create a new one.
- To create a new parameter file enter a new name and click the button „Open“.

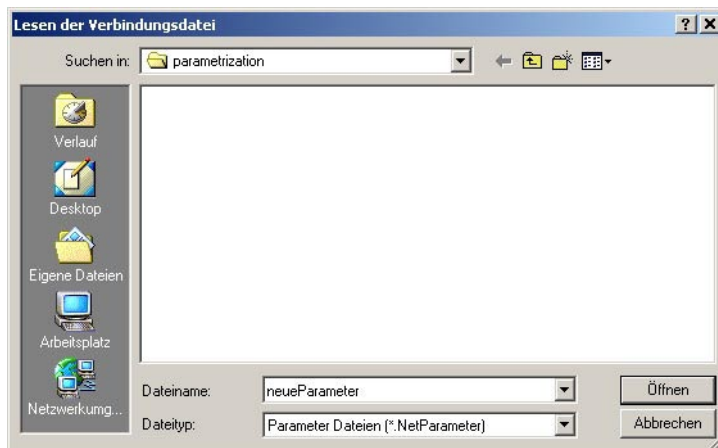

- The window to select the system appears:

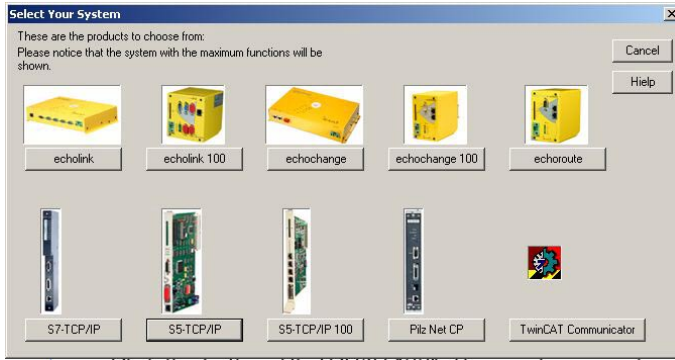

- Click the button „S5-TCP/IP 100“. The empty connection list appears:
- Select Station > Current Station
- The window „Station Parameter Settings“ appears

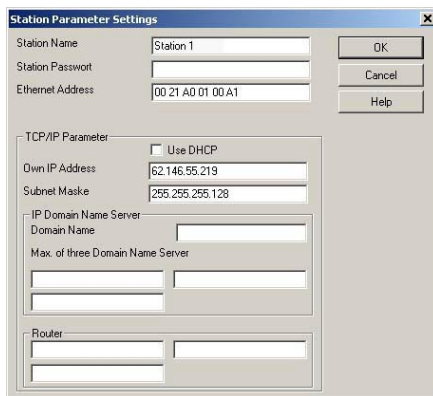

- Please refer to chapter [4.2.1.1 station parameter settings](#) to learn which entries can be made here.
- Confirm your entries with „OK“. You get back to the connection list.
The parameters are stored in the file created at the beginning for later transfer to the S5-TCP/IP 100. This file must be transferred into the S5-TCP/IP 100 (serial or online).

4.3. Setting up connection

Setting up connections is always the same, no matter if you are using online, offline or serial mode.

The difference is: when setting parameters online (via IP or H1), or via serial line the parameters are stored directly in the CP, while when setting parameters off line they are stored in a parameter file.

When setting parameters online all stations on the network are indicated.

To create of a new connection follow these steps:

- Start the parameterization software, select the type of parameterization and select the S5-TCP/IP 100.

Station not found

- Stations located behind routers are not automatically detected.
Establish a direct connection to the desired station clicking the button „New“
- Enter the name and the IP address of the S5-TCP/IP 100 station (these parameters have been defined during the registration process) and click the button „OK“. The new station is indicated in the station list. If there is an arrow in front of the station (->) the station is reachable.
- Mark the S5-TCP/IP 100 in the station list and click the Button „OK“. The empty connection list appears.

-
- To set up a new connection select Connection > New...
 - The window „New connection“ appears

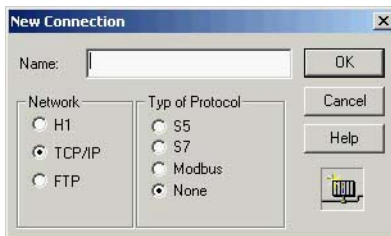

- Here you specify which protocols for the connection are to be used.

NEW CONNECTION
Connection name
All parameterization data is allocated to the connections. Every connection is identified by a connection name.
Network
Select the used network protocol H1, TCP/IP or FTP
Type of Protocol
You can decide which „higher“ protocols (protocols situated on higher layers of the ISO/OSI reference model: application protocols such as S5, S7, Modbus on TCP) to use.
None: Select None when no application protocol to be used (raw data).

- Confirm your entries with the button „OK“. The window „PLC Parameter Settings“ appears. For FTP connection see [chapter 4.4](#).

4.3.1 PLC parameter settings

The PLC parameters regulate the connection between the S5-TCP/IP 100 and the S5 PLC (local parameter)



Connection name

All parameterization data is allocated to the connections. Each connection is identified by a connection name.

Job number (A-NR)

Each connection to be used by the [Siemens S5 standard handling blocks](#) requires a job number. The same A-NR is used in the handling block. With the unique combination job number (A-NR) and SSNR, the connection can be addressed.

If Double connection the Other

Layer 4 communications (Send / Receive) can be handled via one connection, a so-called double-connection. This means, that only ONE connection has to be parameterized for both Sending and Receiving. This connection contains two job numbers, one for Send and one for Receive. With this setting a half-duplex mode is realized.

Job Offset

The job offset determines the page frame which is used for the current job. Job off sets are used normally only in multiprocessor systems (i.e. several CPUs with one or more CPs). The following rule usually applies:

CPU 1 communicates via page frame 1 (Base SSNR + Job offset 0)

CPU 2 communicates via page frame 2 (Base SSNR + Job offset 1)

CPU 3 communicates via page frame 3 (Base SSNR + Job offset 2)

CPU 4 communicates via page frame 4 (Base SSNR + Job offset 3)

The page frame base address is set at the [station parameters](#).

Standard job type

A description of the standard job types can be found in [chapter 3.3 job types](#).

Special Job Type

The Event mode enables spontaneous data traffic. With „normal“ Fetch communication, requested data is sent via network within the Poll cycle even if the data has changed. Data is polled cyclically from the PLC via the network. With Event mode, the S5-TCP/IP 100 compares the requested data. Data is only sent when the data changes. This reduces network traffic. There are two operating modes of the Event Fetch function.

- Single:

The Fetch is started by the calling system. Data is only then returned from the destination system when it has changed. Immediately after the establishment of a connection, data is returned when a fetch is made. The fetch has to be restarted after every data return. This operating mode can also be used in combination with products from other companies.

- Multiple / autom.

The fetch is started by the calling system. Data is returned from the destination system when is has changed. The job does not have to be started again. The responses from the destination system contain an expanded AP header for identification. The header contains the parameters of the call. Therefore it is possible to start several „Multiple / Autom.“ with only one connection. Via these parameters the responses for the different „Multiple / Autom.“ can be identified unambiguous. Entered Multiple / Autom. jobs can be stopped individually.

Poll all

Here you enter the poll cycle for Fetch Event Passive connections. The S5-TCP/IP 100 polls the data from the CPU via the back plane bus. „0“ indicates, that data shall be polled as fast as possible. In order to save calculating time, we recommend using the value „200 ms“.

Do direct jobs always with all

Some older PLC programs require the setting „Do Direct Jobs Always with All“. If this mode is active the data communication is slower and the cycle time load of the CPU is greater. If this mode is not active the data from the PLC is accepted immediately. With this mode data is accepted with the next Senc/Rec-ALL call.

Flag word

An indication word is intended for the passive order types (Fetch passive, Write passive). The indication word, which is specified at the ALL-block, refers to all jobs, which use the ALL function (A-NR = 0). With job types Write Passive and Fetch Passive, the status of communication can only be indicated, if an indication word is parameterized here.



Source / Destination

Source/Dest. is used with the active job types (Write active, Fetch active, Send, Receive). Data source or data destination can be edited here. The values edited here become operative if there are no parameters for Source/Dest. at the corresponding HDB (QTY / ZTYP = NN: no source/destination parameters on the block; Parameters must be present on the CP).

With Send job enter the Source, with Receive job enter the destination. With Fetch active or Write active

Source and Destination are identical.

- Confirm your entries with „OK“. You arrive into the window „TCP/IP Parameter Settings“, „H1 Parameter Settings“ or „FTP Connection“. The creation of a ftp connection is described in [chapter 4.4](#).

4.3.3 TCP/IP Parameter Settings

Destination IP Address

In a TCP/IP network each station is addresses with a unique destination address. If the connection is set „active“ enter the IP address of the communication partner. If the connection establishment is „passive“ enter a joker address (0.0.0.0).

Port

The port number is a 16-bit address from 0 to 65535. It specifies the channel via which the applicable connection is to be established. The port number must be identical on both sides of the connection. The port number is 16 bits long. You should use a port number between 1024 and 65535.

Port number RFC1006

RFC1006 uses the port number 102. This port number is set automatically if you activate the Button RFC1006.

Port number Modbus on TCP

Also Modbus communication is made by a defined port: 502. In contrast to RFC1006 this number can be parameterized. Important: The port must be identical on both sides of the connection.

Connection active / passive

Select the type of connection establishment (i.e. which station is to initiate connection establishment). At regular intervals the active station attempts to set up the appropriate connection.

Protocol TCP / UDP

The TCP (Transmission Control Protocol) is a secure protocol with checksum and acknowledgment. The UDP is not protected. It is handled by datagram services.

Special Settings

PLC Header

If you activate this button for the TCP/IP communication, you are provided with the optimized data transmission to the PLC. Apart from a frame counter, the INAT PLC Header also contains length information and the possibility to send acknowledges. Additional information about PLC headers is available in [chapter 3.4.5 INAT PLC header](#).

Life Data Acks

This item activates the connection monitoring function which is restricted in many socket libraries. The default setting of the life data acks is “activated”.

RFC1006 (ISO on TCP)

TCP/IP data is transferred as a stream. With the activation of RFC1006 this stream is transferred block by block. With that special TCP/IP channel you are able to communicate with the Siemens CPs of the S5 and S7 series. Additional information about RFC1006 is available in chapter 3.4.4 RFC1006.

Click the button RFC1006 to edit the TSAPs:

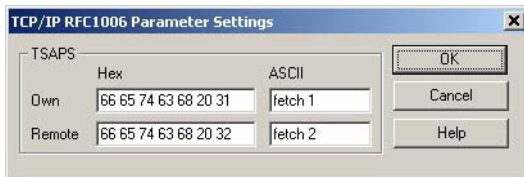

Local TSAP, remote TSAP

The local TSAP (Transport Service Access Point) specifies the connection address in the system by which data is to be exchanged. Remote TSAP specifies the connection address of the other system. In order to develop the connection the TSAPs must be compatible with the „local TSAP“ of the communication partner A and partner B. The „remote TSAP“ of station A must correspond to the „local TSAP“ of station B.

Local TSAP (Station A) = Remote TSAP (Station B)

Remote TSAP (Station A) = Local TSAP (Station B)

TSAPs are 2 bytes up to 16 bytes in length.

Further Settings

Special TCP/IP Settings

Further settings provide special parameters for working with TCP/IP. Normally you do not need them. Further information on these parameters can be found in [appendix](#).

4.3.4 H1 Parameter Settings

Ethernet Address

The destination Ethernet address has to be entered to an active connection. In a passive connection a joker address can be entered (00 21 A0 00 00 00). Enter the Ethernet address of the communication partner in the H1 network.

Local TSAP, remote TSAP

The local TSAP specifies the connection address in the system by which data is to be exchanged. Remote TSAP specifies the connection address of the other system. In order to develop the connection the TSAPs must be compatible with the „local TSAP“ of the communication partner A and partner B. The „remote TSAP“ of station A must correspond to the „local TSAP“ of station B.

Local TSAP (Station A) = Remote TSAP (Station B)

Remote TSAP (Station A) = Local TSAP (Station B)

TSAPs are 2 bytes up to 16 bytes in length.

CR Parameters

With ISO (H1) a transport connection is established by sending a CR TPDU (Connection Request Transport Protocol Data Unit) by an active transport instance. With this CR TPDU several parameters are transferred to the partner such as desired TPDU size, format of the TPDU etc.

Check the user's guide of the destination system to determine what, if anything, must be entered here. If no information is available, no CR parameters should be entered.

Multicast

Multicast connections are connections which are not directed to all stations and which only address the stations which have the same multicast circle number. The number is between 0 and 63.

If Multicast is not selected as the „Line type“, the value for Multicast circle can be disregarded.

Connection active / passive

Select the type of connection establishment (i.e. which station is to initiate connection establishment). At regular intervals, the active station attempts to set up the appropriate connection.

Line Type

The „Line type“ specifies whether the frames of this connection will be sent to all stations (i.e., Broadcast), whether a certain group of stations is to be reached (i.e., Multicast), whether secure connection is to be used (i.e., Normal), or whether the data is to be transferred without protection (i.e., Datagram). Standard is the line type normal. Agree upon other settings for the line type with your network responsible person.

Priority

The line priority can vary from 0 (i.e., highest priority) to 4 (i.e., lowest priority). 0 and 1 are the so-called express priorities while 2 and 3 are the normal priorities. Priority 4 is only used infrequently since a new connection must be established for each sending job. If used infrequently, this priority does not place as much of a strain on the network as other priorities since the line is not monitored (i.e., the connection is disconnected after each sending job). Remember that the express priorities do not make transmission faster than the normal priorities. On some controllers, however, the data are transferred to working storage via interrupt when priority 0 is used. This can make the total data transmission faster.

With priority 0 and 1 can amount to the data length maximally 16 bytes.

According to standard line priority 3 is set.

- Click the button „OK“. The connection parameter setting is finished. The new connection is indicated in the connection list.

4.4 FTP Connection

FTP connections permit the S5-TCP/IP 100 to be addressed from any FTP client. The FTP commands GET and PUT are supported.



Number of

Maximum number of clients that access the PLC.

Job number

Job number for read and write jobs. All PUT and GET requests are handled via this job number. PUT requests are only handled if write jobs are allowed. Write jobs can be disabled.

Use connection name as password for read job

Activate this button and the connection name is the code word for read jobs. If no code word is specified, read accesses can always be performed.

Use station password for write jobs

Activate this button and the station password edited in the windows „Station Parameters“ is the code word for write jobs. If no code word is specified, write accesses can always be performed.

Write access permitted

As default Write accesses are not permitted. This can be changed here.

Connection works

A parameterized connection can be deactivated. The parameters are not lost! The connection can be activated with the same parameters again. As default connections are active.

NOTE:

For GET the SEND ALL block and for PUT the RECEIVE ALL block must be programmed

NOTE:

Only one active FTP entry in the list is possible. With the entry of a ftp connection the ftp server of the S5-TCP/IP 100 is started. As many clients can access the controller as entered under „number of“.

4.4.1 Read / Write data with a FTP client

- Start the command line of your operating system and change you into the desired work listing
- ftp: Enter to ftp. With ftp you start the file transfer protocol
- open x.x.x.x: open starts the ftp server of the station with the address x.x.x.x (x.x.x.x = IP address of S5-TCP/IP).
- binary: The data blocks are stored as binary in the PLC. Therefore the ftp transfer has to be performed in the binary mode.

4.4.2 Formats of commands:

The formats of commands are the same for the command PUT and command GET! All kinds of data blocks DX and flags MB can be transmitted.

get db 10	reads the whole DB 10
get db10dw26	reads DB 10 from DW 26 up to the end
get db10dw26len5	reads DB 10 from DW 26, 5 words

At GET the data blocks will be saved in that directory, where you started FTP or into which you changed while the FTP session (in the example down the data blocks become stored on drive d:).

At PUT the data blocks will be taken out of the directory, where you started FTP or into which you changed while the FTP session.



```

Microsoft Windows 2000 [Version 5.00.2195]
(C) Copyright 1985-2000 Microsoft Corp.

C:\>d:
D:\>ftp
ftp>open 192.168.1.7
Verbindung mit 192.168.1.7 wurde hergestellt.
230 Connected to INAT Network Component OK
Benutzer (192.168.1.7:(none)):
230 Connected to INAT Network Component OK
ftp>binary
220 Mode set
ftp>get db10dw10len25
200 Port OK
150 Transmission Running
226 Transfer complete
FTP: 50 Bytes empfangen in 0,49Sekunden 0,10KB/s
ftp>

```

Transmission running	transmission runs
Transfer complete	Transfer is finished. Number of transferred bytes is indicated with transmission time.
Close	The ftp connection to the server is disconnected.
By(e) / Quit	With Bye or Quit the ftp session ist stopped.

4.5 Standard connections

Standard connections are available at the S5-TCP/IP 100. Standard connections are pre-parameterized connections for Layer 7- communications. On CP side no more settings are necessary. In the partner station parameterizing of the connection is of course required.

<i>Port number</i>	<i>Connections</i>	<i>Used protocols</i>
Port 990	2 connections	<ul style="list-style-type: none"> – S5 protocol – TCP/IP – without PLC header
Port 991	5 connections	<ul style="list-style-type: none"> – S5 protocol – TCP/IP – with PLC header

4.6 Modbus table

The modbus table enables the assignment of modbus registers to data blocks and / or other data types of the automation system.

Since the S5-TCP/IP 100 understands the Modbus on TCP protocol, communication is possible between the S5 PLC and Modbus devices, for example: a Schneider PLC or a Wago controller.

If the S5-TCP/IP 100 Modbus on TCP data receives, then these must be converted for the forwarding to the S5-CPU accordingly, so that the data in the S5 program can be further processed.

If the S5-TCP/IP 100 sends data to Modbus device, then must be converted from the S5-CPU data submitted accordingly, so that the data in the Modbus equipment can be further processed.

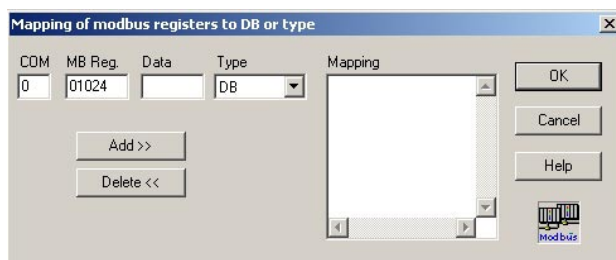

Register		
In this field the Modbus register number is registered. The counting method begins with 0 (only with some Modbus OPC servers the counting method begins with 1). The field is reserved with a default value, which computes itself from the entry with the highest register number and its type (Example: the on a data block following register is higher around 1024!)		
Block		
If the type is DB or DX, the block number is indicated here. For the other types the value is set automatically to zero.		
Type		
Enter the data type here. The following allocations apply:		
Type	Meaning	Identification
DB	Word from data block	1
FW	Flag Word	2
IW	Input Word	3
QW	Output Word	4
PW	Peripheral I/O	5
CW	Counter	6
TW	Timer	7
RS	Running system data	8
AS	Absolute memory	9
DX	Extended data block	10
XW	External memory data	16
OW	Extended peripheral I/O	17

CHAPTER 5:

MENU FUNCTIONS



5 MENU FUNCTIONS

In this chapter the individual dialogue windows of the parameterization software are described in detail.

5.1 Station list

In the station list all stations which are currently available online on the network are shown (Note: stations behind routers are not detected).

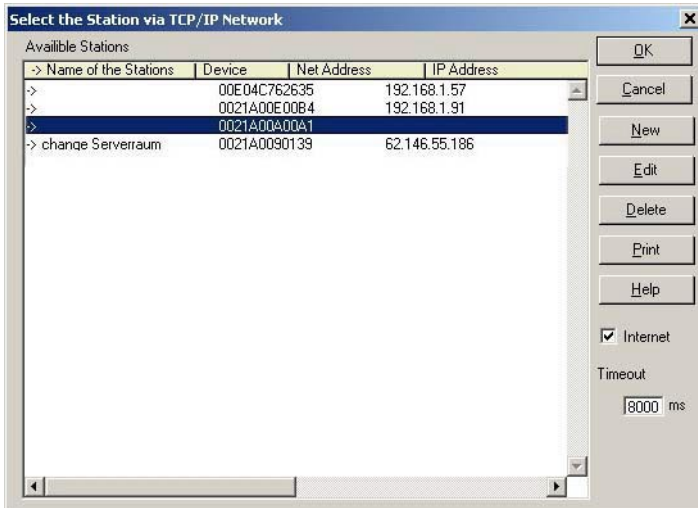

- All stations marked with an arrow (->) at the beginning of the line are stations which are currently available online on the network. There all INAT stations are indicated like e.g. S5-TCP/IP 100, echolink or echochange.
- The cell width of the station list entries „station name“, „device“, „net address“, „IP address“ and „type“ is variable.

5.1.1 Station not found

If the S5-TCP/IP 100 has not been detected, possible causes are:

STATION NOT FOUND	
<i>Interface via the network</i>	<i>Serial Interface</i>
The station is turned off	The connection cable may not be plugged in.
The protocol (i.e., H1 or TCP/IP) used for the connection is not correctly installed on your operator-control computer.	The connection cable is allocated incorrectly.
The station is situated behind a router	The interface card on your PC is defective.
	The interface on your PC is being used for another task.

5.1.2 OK

- If you mark a station, for which the station parameters were already assigned, the connecting list appears with „OK“. Here all available connections for this station are indicated. The connection establishment is monitored and after approximately 5 seconds without a response from the selected station, the connection establishment is canceled.
- If you mark a new station, which is only indicated with MAC address, the window „Station Parameter Settings“ appears with „OK“.

5.1.3 Cancel

Click the button „Cancel“ and you leave the station list and the start dialog window appears again.

5.1.4 New

If a station has not been detected in the automatic online display (parameterization via IP), establish a direct connection to the desired station using „New“.

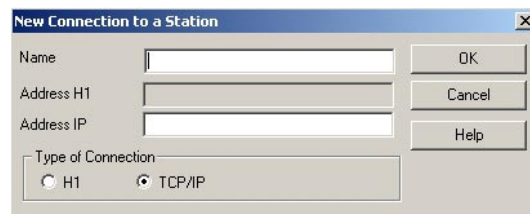

Enter the name and the IP address of the S5-TCP/IP 100 station (these parameters have been defined during the registration process as described in chapter 4.1.2) and click the button „OK“. The new station is indicated in the station list. If there is an arrow in front of the station (->) the station is reachable.

5.1.5 Edit

Station parameters of stations reached via the button „New“ can be modified in this window. Station name and IP address can be changed.

5.1.6 Delete

Stations reached via the button „New“ can be deleted here. Each time you try to delete a station a confirmation window appears asking whether you really want to delete this station.

Deletions are irreversible!

5.1.7 Print

A list of the stations can be printed for documentation purposes. The printout is made on the standard printer specified for the system.

5.1.8 Help

The Online help of the parameterization software appears.

5.1.9 Internet

Activate the button Internet, if stations shall be reached via Internet.

5.1.10 Timeout

With the connection timeout the Timeout according to standard of the system values can be affected purposefully for this connection. That is meaningful e.g. for connections in the Internet, with which the life telegrams were deactivated. Please you note that also the response time is high with connecting disturbances then (e.g. by cable break)

5.2 Connection window

In this window you edit existing connections and set up new connections. On the left side all stations stand available in the net. If you activate a station, then the connections in the order, parameterized for this station, are indicated, in which they were entered. You recognize the straight selected station by the green marking. Each connection is indicated with the following parameters:

CONNECTION PARAMETERS	
<i>Type</i>	Network protocol: IP, H1 or FTP
<i>Name of connection</i>	Name of connection as edited during connection set up
<i>No</i>	Job number(s) and application protocol
<i>Job</i>	Send Direct, Receive Direct, Fetch active, Fetch passive, Write active, Write passive or FTP
<i>Act</i>	Client = active connection establishment Server = passive connection establishment
<i>Dest</i>	Destination IP address (TCP/IP connection) or Destination Ethernet Address (H1 connections)
<i>Parameters</i>	Port or TSAP, Headers

- With a mouse-click or with the cursor key you select a connection and edit with the buttons. With a double click the window on the select connection „Connection Settings“ appears (see chapter 5.2.3.1 „Connection“).
- If a connection is marked click the right mouse button and several functions such as „Switch Active / Passive“ or „Delete“ are available.

5.2.1 Functions via right mouse button

Mark a connection and click the right mouse button, the following functions are available:

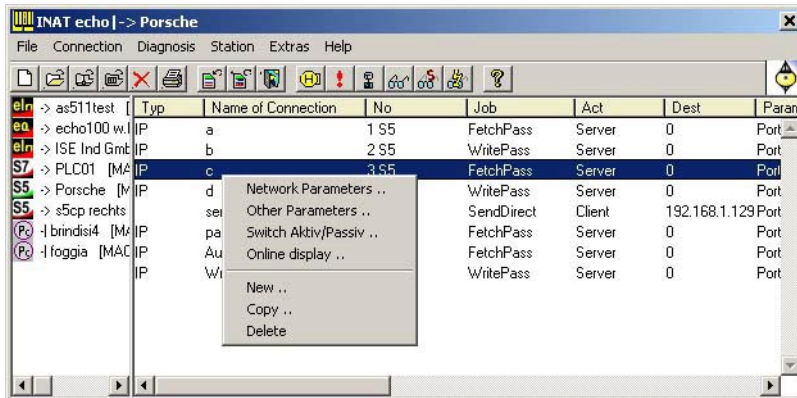

FUNCTIONS VIA RIGHT MOUSE BUTTON	
Network Parameters....	Reachable with menu Connection. Description in chapter 5.2.3
Other Parameters....	Reachable with menu Connection. Description in chapter 5.2.3
Switch Active / Passive...	A connection can be deactivated here. Connection parameters are not lost. At a later date the connection can be set active again with the same parameters.
Online display...	Reachable with menu Diagnosis. Description in chapter 5.2.4
New...	A new connection can be set up here. Description in chapter 4.3 „Setting up connection“
Copy...	A connection can be copied and modified.
Delete	Deletes a marked connection.

5.2.2 Menu File

The menu file provides the following functions:

MENU FILE	
<i>Load File to Device..</i>	Description in chapter 5.2.2.1
<i>Store Data to File.</i>	Description in chapter 5.2.2.2
<i>Print</i>	Description in chapter 5.2.2.3
<i>End</i>	Description in chapter 5.2.2.4

5.2.2.1 Load File to Device

An existing parameter file can be sent to the S5-TCP/IP 100 here. New parameter files can be created here.

Select the drive and the directory, where the parameter file is stored. The parameter files are shown. Mark the desired file and click the button „Open“. The parameter file will be loaded to the S5-TCP/IP 100.

You can create also a new file here. Enter in addition simply under file name to the desired new names and click you to the button „Open “.

5.2.2.2 Store Data to File

With „Store Data to File“ you can save your parameter data.

5.2.2.3 Print

A list of the connections can be spent for logging. In order to be able to assign this printout, you should indicate meaningful data in the input fields company name, project and programmer. The printout is spent on the standard printer indicated in the system.

5.2.2.4 End

With „End “you leave the connecting window and arrive back at the starting dialogue window of the parameter setting software.

5.2.3 Menu Connection

The menu connection provides the following functions:

MENU CONNECTION	
Connection..	Description in chapter 5.2.3.1
Network Parameters..	In this window the „TCP/IP Parameter Settings“ and/or „H1 Parameter Settings “ are displayed.
PLC Parameters..	This window corresponds to the dialogue that appears when one creates a new connection.
Switch Active / Passive...	A connection can be deactivated here. Connection parameters are not lost. At a later date the connection can be set active again with the same parameters.
Neu	The window New Connection appears here.
Copy...	An existing connection can be copied here. If you register a new name for the copied connection and if you confirm with „OK“, then the connection in the connecting overview is indicated.
Delete	The marked connection is deleted. Deletions are irreversible.

5.2.3.1 Connection...

The window „Connection Settings“ appears.

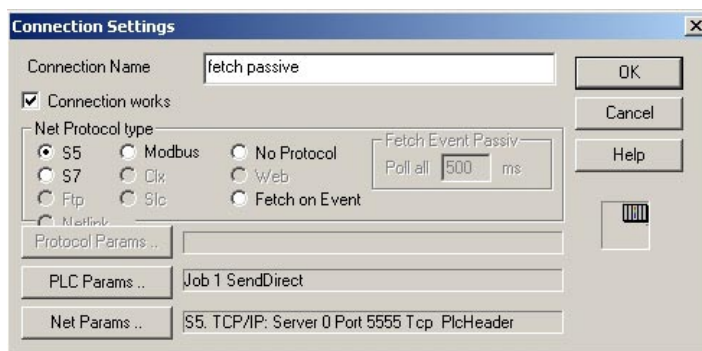

The parameters of the connection are shown in overview. The Buttons PLC Parameters... and Net Parameters... take to the appropriate window of the PLC Parameter Settings and/or the Net Parameter Settings.

5.2.4 Menu Diagnosis

The menu diagnosis provides the following functions:

MENU DIAGNOSIS	
<i>Display Connection Status</i>	Description in chapter 5.2.4.1
<i>Monitor all connections</i>	Description in chapter 5.2.4.2
<i>Monitor Standard connections</i>	Description in chapter 5.2.4.3
<i>IpStati</i>	<i>at present without meaning</i>
<i>Rfc1600Stati</i>	<i>at present without meaning</i>
<i>Page Frame Diagnosis</i>	Description in chapter 5.2.4.4
<i>Fetch on Event Cach Status...</i>	Description in chapter 5.2.4.5

5.2.4.1 Display Connection Status

The status window is used to monitor a connection. The connection name is indicated in the headline.

<i>Status window for a double connection</i>	<i>Status window for a simple connection</i>
<p>Status: sendreceive</p> <p>Auftragsnummer 171 PC -> SPS <input type="button" value="Ende"/></p> <p>Anzeigewort Send 2 Läuft <input type="button" value="Hilfe"/></p> <p>Anzeigewort Rec 2 Läuft</p> <p>Netz Status Warte auf Quittung</p> <p>Telegramme Send 3332 Rec 3343</p>	<p>Status: senddirekt</p> <p>Auftragsnummer 170 PC -> SPS <input type="button" value="Ende"/></p> <p>Anzeigewort Send 4 Fertig ohne Fehler <input type="button" value="Hilfe"/></p> <p>Anzeigewort Rec</p> <p>Netz Status OK</p> <p>Telegramme Send 200 Rec 0</p>

Job Number

The job number (A-NR) is indicated here. With double connections only the job number is indicated, which was registered in the parameter setting software, in the window „PLC Parameter Settings“ in the field „Job No.“. The job number under „If Double Connection the Other“ is not indicated.

Indication Send + Rec

For each job an indicator word is assigned whose contents are indicated here. If data are sent then the status of the send job will be indicated under indicator word Send. If data are received then the status of the receive job will be indicated under Receive.

If you have parameterized a double connection (a connection with 2 job numbers), then the status is indicated for both jobs.

The indicator word is evaluated and displayed as a hexadecimal code. Behind the hex value the plaintext of the indicator word follows.

Allocation of the indicator word

Set Bit	Indicated value in Hex	Meaning
0	1	Job ready
1	2	Job running
2	4	Job finished without errors
3	8	Job finished with errors
4	10	Data transfer / acceptance running
5	20	Data transfer finished
6	40	Data acceptance finished
7	80	Data transfer / acceptance disabled
1,3,5,7	AA	No connection to the other system
1,3,4,5,6,7	FA	Job does not parameterize

Net Status

Status shows the current condition of the net connection. Net status can indicate the following messages: „OK“, „Wait for ACK“ and „No connection“.

Frames Send + Rec

Indicates the number of sent and/or received frames.

5.2.4.2 Monitor all connections

Besides the connection name, type and connection parameters, the number of sent and received frames and the number of disconnects, is indicated for the left side and the right side. The entry L or R in the column „Slave“ indicates whether the left side or the right side is set to slave mode (see [chapter 5.2.4.1 Display Connection Status](#))

5.2.4.3 Monitor Standard connections

When using standard connections, they can be monitored here. The connections are indicated with type, name, job number, indicator word, net status as well as sent and received frames. The meaning of the individual parameters correspond to those how with the diagnosis of an individual connection (see [chapter 5.2.4.1 Display Connection Status](#))

5.2.4.4 Page Frame Diagnosis

The window „Extended Diagnosis“ helps you to locate the causes for communication malfunctions. It is shown for all page frames whether they are synchronized. If a page frame is synchronized, its block size is also shown.

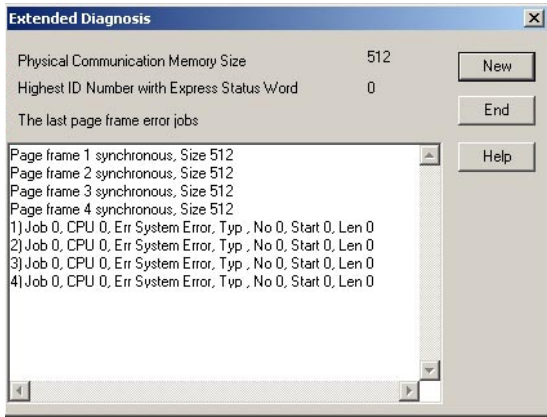

If jobs have been processed incorrectly by the controller, up to ten error jobs are indicated. The following information is given for each error job: Job Number, CPU Number, Job Identifier, Block Number, Offset on the Block and Length of the Area. By clicking „New“, you can view the refreshed values in the indication.

5.2.4.5 Fetch on Event Cache Status

Fetch on event connections are monitored separately in this windows.

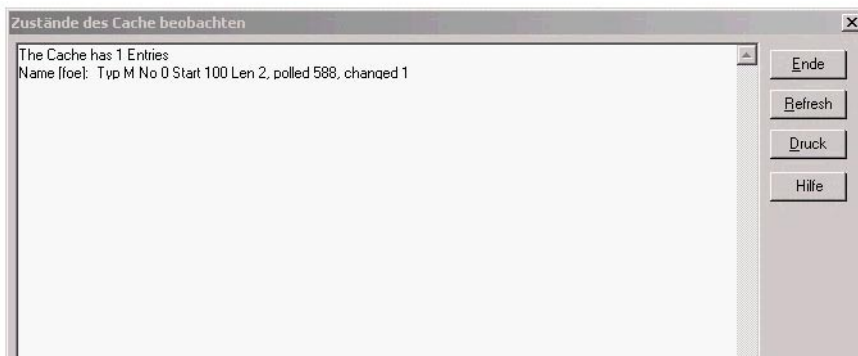

For each FOE connection the following parameters are indicated:

- Name: Connection name of the projected event connection
- Type: data type (flag, data block etc.) of the monitored area
- Start: Start address
- Len: Length of the monitored area
- Polled: Poll cycle of the CP
- Changed: number of value changes

5.2.5 Menu Station

The menu station provides the following functions:

MENU STATION	
<i>Station list</i>	The station list (only with online parameterization) appears. Description in chapter 5.1
<i>Current Station</i>	The window to edit the station parameters appears. Description in chapter 4.2.1.1
<i>SNMP Settings..</i>	Description in chapter 5.2.5.1
<i>Original Address</i>	If you confirm with „Yes“ the hardware address of the INAT S5-TCP/IP is reset to the default value.

5.2.5.1 SNMP Settings...

The SNMP services (Simple Network Management Protocol) serve the administration of the nets. The following parameters can be edited:

SNMP STATION SETTINGS	
<i>Main Community</i>	„Main Community“ is the identifier with which all services on the INAT S5-TCP/IP can be addressed. If no identifier is entered here, all stations can perform accesses.
<i>Read Community</i>	„Read Community“ is the identifier for read-only access. If no identifier is entered here, all stations are read-accessible. Write-access is not permitted with this identifier. The main community is used for this.
<i>Accessing station</i>	„Accessing station“ can be further restricted in addition to the identifiers. If an address other than 0 is entered here, write-access can only be performed by the station specified here.
<i>Station Getting Traps</i>	Traps are sent to the station entered in „Station which is getting traps“. If no station is entered here (i.e., value is 0), no traps are generated. SNMP services are addressed via port 161. Traps are sent on port 162.

5.2.6 Menu Extras

The menu extras provides the following functions:

MENU EXTRAS	
Parameter -> Flash Card	Description in chapter 5.2.6.1
H1 System Values	Description in chapter 5.2.6.2
TCP/IP System Values	Description in chapter 5.2.6.3
Delete all Connections	All connections are deleted.
PLC System Values	Description in chapter 5.2.6.4
Clock Functions	Description in chapter 5.2.6.5
Modbus Table	Over the Modbus table you assign the registers to the desired data types. Description in chapter 4.6
License	<i>for S5-TCP/IP 100 not relevant</i>
Diagnosis serial	Description in chapter 5.2.6.6
Firmware Update	Description in chapter 5.2.6.7

5.2.6.1 Parameter -> Flash Card

The S5-TCP/IP 100 with the slot for a memory card offers additional backup capacity. The „Parameter -> Flash Card“ function copies the parameters of the component to the Flash Card in the module slot. Thereto the compatible Flash Card must be inserted in the module slot. Before the loading a safety inquiry takes place. Further information to the Flash Card are described in [chapter 2.1.1 Compact Flash](#).

5.2.6.2 H1 System Values

The H1 system parameters represent the operating parameters of layer 4. The values should only be changed in special cases. Please ask your system administrator before changing these values.

Time-interval „Fast CR“

This value specifies the time interval between two Connect Request attempts (if the connection cannot be established) **before** the maximum number of CRs is exceeded and sending becomes slower. Default-moderately after 20 futile CR attempts the temporal gap is increased to „Time-interval Slow CR “.

Time-interval „Slow CR“

Specifies the time interval between two Connect Request attempts (if the connection cannot be established) **after** the maximum number of CRs is exceeded and sending becomes slower. Default-moderately this case arises after 20 futile CR attempts.

Number of CRs at which CRs are sent slower

This value specifies the number of unsuccessful Connect Request attempts after which the attempts are performed less frequently. This reduces the network load caused by unsuccessful attempts to establish connections. After each connection establishment and disconnection, the system attempts to re-establish the connection.

Time-interval Sending Repeats

Time interval between the first and second attempt to send.

Number of Sending Repeats Attempts

The number of repeated attempts to send data with the same sequence number.

Timeout Life ACKs

Time without data communication after which the connection is considered interrupted.

Time-interval Life ACKs

Specifies the time after which an acknowledgment is to be sent when no data communication takes place.

Maximum Credit

It is the maximum value for the credit. Credit is the number of TPDU's (Transport Data Control Unit) which may be sent without ACKs by the sending station from the destination station.

Maximum TPDU Length (code)

Maximal value of an H1.

Class Options

Some of the services offered by the H1 classes 0 to 4 may be activated within the „Class Options“.

Protocol Options

By the HEX value 3 you may activate the Checksum and the Expedited Data Transfer.

5.2.6.3 TCP/IP System Values

The TCP/IP system parameters represent the operating parameters in the TCP/IP kernel. The values should only be changed in special cases. If it is necessary to change the values, please ask your system administrator.

Time-interval „Fast CR“

This value specifies the time interval between two Connect Request attempts (if the connection cannot be established) **before** the maximum number of CRs is exceeded and sending becomes slower. Default-moderately after 20 futile CR attempts the temporal gap is increased to „Time-interval Slow CR“.

Time-interval „Slow CR“

Specifies the time interval between two Connect Request attempts (if the connection cannot be established) **after** the maximum number of CRs is exceeded and sending becomes slower. Default-moderately this case arises after 20 futile CR attempts.

Number of CRs at which CRs are sent slower

This value specifies the number of unsuccessful Connect Request attempts after which the attempts are performed less frequently. This reduces the network load caused by unsuccessful attempts to establish connections. After each connection establishment and disconnection, the system attempts to re-establish the connection.

Time-interval Sending Repeats

Time interval between the first and second attempt to send.

Number of Sending Repeats Attempts

The number of repeated attempts to send data with the same sequence number.

Timeout Life ACKs

After this time without data traffic the connection applies as interrupted. TCP/IP normally uses no life telegrams as long-distance traffic telegram. Thus the connection is also interrupted, if in the indicated time no data will transfer.

Time-interval Life ACKs

Specifies the time after which an acknowledgment is to be sent when no data communication takes place. This value can be zero for the TCP/IP. If so, this will disable the life telegrams.

Maximum Frame Length

Is the maximum number of bytes which are transferred in a telegram.

Timeout for ARP entries

Determines the time after which an entry in the ARP cache (Address Resolution Protocol) becomes invalid. Each access to a certain address on the cache sets the value again.

Timeout for DNS

Determines the time after which a name could not be converted into an IP address.

Timeout for Life Data ACKs

Time without data communication after which the connection is considered interrupted. Since the TCP/IP usually does not use life telegrams as long-distance telegrams, the connection is also interrupted when no data have been transferred during the specified time.

After this Time without Data an ACK is Sent

After 165 Acks the Timeout for Life Data Acks is dropped and the connection is considered interrupted.

Start Value for Next Free TCP Port

Is used for TCP connections for which both ports are not specified. If a port is parameterized as 0, a port number is generated. The numbers which are used start at the value given here.

Start Value for Next Free UDP Port

The same for UDP connection.

Wait factor if no PLC Header

If the header is eliminated, the integrated connection control will also be finished. Therefore if you use long-distance telegrams it is recommended you increase the timeout for Life ACKs. Standard value for this factor is 5.

Wait factor if no RFC1006 Header

If the header is eliminated, the integrated connection control will also be finished therefore if you use long-distance telegrams it is recommended to increase the timeout for Life ACKs.

Allow ICMP Broadcast

The ICMP (Internet Control Message Protocol) is a protocol used by the Internet Protocol Layer, to interchange control information for routing

5.2.6.4 SPS System Values

These values influence the behaviour of the S5 TCP/IP-100 to the PLC.

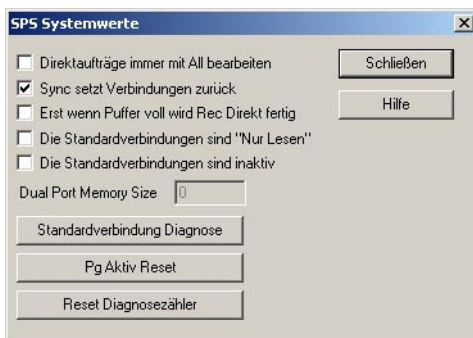

Do Direct Jobs Always with All

Some older PLC programs require the setting „Do Direct Jobs Always with All“. If this mode is active the data communication is slower and the cycle time load of the CPU is greater. If this mode is not active the data from the PLC is accepted immediately while in „Do Direct...“ mode the data is not accepted until the next Send/RecAll call.

NOTE

In this windows this function is edited globally for all connections of this station, while the same function in the window „PLC Parameter Settings“ applies exclusively to the marked connection.

Sync Resets all Connections

„Sync Resets all Connections“ stops all connections and restarts them if the PLC is switched from STOP to RUN. All data which is in the receiving buffer is deleted. This is necessary for Fetch- und Write-connections because the internal status of the data transfer between both stations is no longer defined.

If this mode is not active the connections are preserved when a restart is made. When running Fetch- or Write-jobs this can force inconsistent states because the stopped PLC doesn't manage data transfer via the internal rack communication. If this mode is active each Fetch, Write, Fetch Passive/Write Active connection has to be reset when the PLC is switched to RUN. In that case no data is lost because Send Direct und Receive Direct jobs, in the PLC are switched from STOP in RUN.

Receive finishes if Buffer is Full

If „Receive Direct is Finished if Buffer is Full“ is active the Rec Direct jobs are finished without errors only if the number of received data is equal to the number you have specified for the job in the PLC. All end checks of the network protocols are ignored. e. g. if a network frame sends more data then you would like to receive with Rec Direct the left over data are delivered to the next Rec Direct.

The Standard connections are read only

Writing to the PLC can be forbidden global for all standard connection here

The Standard connections are inactive

All standard connections can be set inactive here.

Dual Port Memory Size

This function is not relevant for the S5-TCP/IP 100.

Standard Connections Diagnostics

The window „Diagnostics of the Standard Connections“ appears (see also [chapter 5.2.4.3](#))

Pg Aktiv Reset

With this button you can reinitialize the PG interface without a reboot of the connected PLC. That reset button enables you to shorten the timeout interval after serial PG accesses.

5.2.6.5 Clock functions

The clock functions of the S5-TCP/IP 100 provide the following services:

1. Management of the internal time: The time is led on the CP.
2. Slave: The time of the S5-TCP/IP can be synchronized by time telegrams.
3. Master: The S5-TCP/IP can send synchronous telegrams as time masters.



Setting the clock

Enter hour, minute and second, day, month and year. Click the button „Set“. Values are transferred to the S5-TCP/IP 100. The weekday is then indicated automatically. As long as no inputs take place, the clock keeps running. Inputs stop a refurbishing of the announcement.

General

Time can be synchronized with synchronization telegrams. The station sending these telegrams is called clock master. Stations receiving these telegrams are called clock slaves. The S5-TCP/IP 100 can be configured both: master or slave.

S5-TCP/IP 100 as clock slave

In case of being clock slave, the S5-TCP/IP 100 receives the synchronization telegrams from the clock master. The slave function cannot be deactivated i.e. if the S5-TCP/IP 100 is NOT configured as master, it is ALWAYS clock slave and receives corresponding telegrams.

S5-TCP/IP 100 as clock master

If master is activated, the INAT S5-TCP/IP 100 sends the time at the specified interval.

Multicast No	<p>Broadcast: Value to enter „0“: Telegrams are sent to everybody. All stations in the network, that are configured as clock slaves are synchronized.</p> <p>Multicast: Value to enter „arbitrary“: Telegrams are sent to all stations that are member of the multicast. The time of these stations are synchronized.</p> <p>Multicast: Value to enter „239“: If there is a CP1430 in the network using the Multicast clock, enter 239</p>
Interval	<p>Here the interval is registered in seconds, with which the time master sends synchronization telegrams. E.g. if the value 20s is adjusted, the master sends all 20 s a time telegram to the clock slaves. Make sure that the interval of the Master and the Standby masters is identical.</p>

Availability if time to the PLC

Job number 218 is available for an application program on the SIMATIC S5 for editing the time. A SEND with this job number causes a write access while a RECEIVE causes the time of the S5-TCP/IP to be read.

The time is available to the PLC in the following data format:

	<i>Bit 12-15</i>	<i>Bit 8-11</i>	<i>Bit 4-7</i>	<i>Bit 0-3</i>
<i>DW n:</i>	10s seconds	1s seconds	1/10 sec	1/100 sec
<i>DW n+1:</i>	10s hours	1s hours	10s min	1s min
<i>DW n+2:</i>	10s days	1s days	day of the week	
<i>DW n+3:</i>	10s years	1s years	10s mon	1s mon
<i>DW n+4:</i>		1/1000 sec	+/- Time difference	

<i>Format</i>	<i>Value Range</i>
1/1000 sec	0 to 9
1/100 sec	0 to 9
1/10 sec	0 to 9
1s sec	0 to 9
10s sec	0 to 5
1s min	0 to 9
10s min	0 to 5
1s hours	0 to 9
10s hours	0...1 / 0...2 Bit 15 = 1: 24 h-format Bit 15 = 0: 12 h-format Bit 14 = 0: AM Bit 14 = 1: PM
Day of the week	Mon to Sun = 0 to 6
1s days	0 to 9
10s days	0 to 3
1s months	0 to 9
10s months	0 to 1
1s years	0 to 9
10s years	0 to 9

5.2.6.6 Diagnosis serial

Thus you can diagnose serial communication. They can indicate communication directly in the window or in a file (c:\\Stationsname.txt) store. You can store this file as txt-file or html-file.

Apart from unique reading in, cyclic reading in is also possible (duration-debug in windows and/or duration-debug in file).

5.2.6.7 Firmware Update

If single file is to be updated, select **Extras > Firmware Update**. Click the button „Open“.

The file is loaded to the S5-TCP/IP 100. You will receive complete updates via Email (.exe) from INAT GmbH. Follow these steps:

- You receive a compressed file from INAT GmbH via Email or on CD.
- Store this file locally on your hard drive.
- Unpack the file.
- Start the file Cp_upd.exe.
- DOS program starts. You are asked to enter the IP address of the S5-CP.
- Enter the IP address and press „Enter“.
- Wait for the update procedure. The following dialogue appears:

```

D:\temp\cp-upd\Cp_upd.exe
Bitte beobachten Sie nun die LEDs auf der Frontseite der CP.
Diese muessten nun wahllos anfangen zu blinken.
Erst wenn dieses Blinken laenger als ca. 10 Sek. aufhoert
ist das Update der CP komplett fertig.
BITTE BOOTEN SIE DANN DIE CP NEU.
Danach ist sie wieder betriebsbereit.
** Programm beendet **
Beliebige Taste betätigen...

```

















- If the blinking of the LED stops on your S5-TCP/IP 100 longer than 10 seconds, boot the communications processor CP again.
- Afterwards the S5-TCP/IP 100 is again ready for use.

5.2.7 Menu Help

The menu help provides the following functions:

MENU HELP	
Content	The contents of the online help are shown.
Version	The versions of all program modules are available in this window.
About	The program info window.

5.2.8 Buttons of the connection window

BUTTONS	
<i>Button</i>	<i>Description</i>
	Set up a new connection
	The window „Connection Settings“ appears
	Show/Edit network parameters of marked connection
	Show/Edit PLC parameter of marked connection
	Delete marked connection
	Print connection list
	Copy the parameters to the S5-TCP/IP 100
	Copy the parameters to a file
	Close of the connection window
	The window „Station Parameter Settings“ appears
	PLC interfaces diagnosis
	Display connection status
	Monitor all connections
	Monitor standard connections
	Diagnosis of the Fetch on Event Cache
	Online Help

APPENDIX



APPENDIX

Special TCP/IP Settings

With the button „Further Settings“ in the TCP/IP Parameters Setting window, the dialogue „Special TCP/IP Settings“ appears.

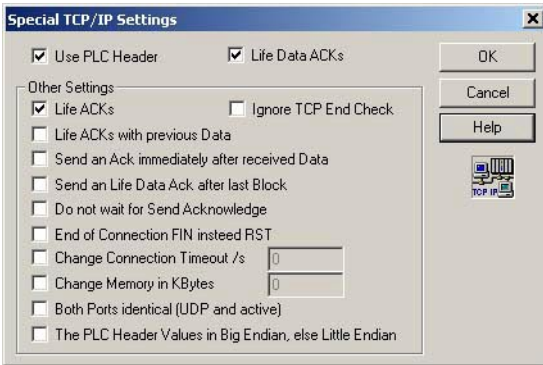

These special parameter settings for working with the TCP/IP do not have to be edited in normal use. They have the following meaning:

SPECIAL TCP/IP SETTINGS	
<i>Use PLC Header</i>	
	The header can be switched off here.
<i>Life Data ACKs</i>	
	This item activates the connection monitoring function. The PLC header must be active. Interruptions, such a cable break, are recognized very fast with the help of this function. In a LAN or a cell network this monitoring mode is very useful. If the connection is being handled by a WAN, we recommend deactivating these functions to save costs, since those TCP/IP connection is always active
<i>Ignore TCP End Check</i>	
	When reading the data with this point, the end identifier is deactivated by TCP/IP telegrams. Therewith so many data are handed over, how the PLC program requests. The job is only then terminated correctly („job finished without errors“). See also „PLC of system values: first if buffer full...“! This setting is only with Receive direct connections and for the CPs such as S7-TCP/IP, S5-TCP/IP as well as echolink. (does not apply to echochange!)
<i>Life ACKs with previous data</i>	
	Some IP Stacks e.g. Windows NT only answer to Life ACKs, if there is data included. If this flag is set active INAT units send Life ACKs with 1 byte data. If the flag is not set active, life ACKs are sent without data.
<i>Continuation next page...</i>	

<i>Send an Ack immediately after received data</i>
This setting is for speed. Normally TCP/IP acknowledges receipt of data after a certain waiting time (Must Ack Time). With this setting the acknowledgement takes place at once. Background: This is useful for cyclic transmission of data in a LAN. TCP/IP as long-distance traffic net usually collects several data blocks before an acknowledgement takes place. For cyclic sending of data blocks in short intervals, this setting is useful for faster transmission.
<i>Send a Life Data Ack after last Block</i>
(for communications via Socket Libraries). Many socket implementations do not advise of the IP acknowledgement telegram. With this function a life data ACK is sent at once as an acknowledgement. This function is only available with communications via PLC header or RFC1006.
<i>Do not wait for Send Acknowledgement</i>
(for communications via Socket Libraries). Many socket implementations do not advise of the IP acknowledgement telegram. With this function, INAT units send without having received an acknowledgement. This function is only available with communications via PLC header or RFC1006.
<i>End of Connection FIN instead RST</i>
Some IP implementations require a „graceful shutdown“, i.e. a FIN flag instead of a RST flag. With activating this flags, connection establishment of the INAT units is started with a FIN flag.
<i>Change connection timeout</i>
With connection timeout the standard timeout of IP system values (30s) can be changed exclusively for this connection. This is useful for Internet connections, where Life ACKs have been deactivated. Please you note that the response time is likewise high re connecting disturbances, as e.g. cable break.
<i>Change memory in KBytes</i>
The memory for this connection can be changed. The minimum memory space for a connection is 1460 bytes (Ethernet maximum of user data). For broadcast receive connection (UDP) this is not enough. If data from the partner station is sent faster than the PLC receive it, then the overflow is stored in this memory. Only when this memory is full the UDP data is rejected.
<i>Both ports identical (UDP and active)</i>
The source port and the destination port are set to the port edited in the parameterization. The automation of INAT units to set the source port to a value > 1024 will then be deactivated (see TCP/IP System Values). This setting is required for communications with CPs that do not support data transfer via UDP.
<i>The PLC header values in Big Endian, or Little Endian</i>
If this flag is set active, the sequence number in the PLC header is transferred in MOTOROLA Format (Big Endian). Normally (flag is not set active), the sequence number is transferred in PLC header in INTEL Format (Little Endian).

INDEX

Symbols

0021A0 38

A

A-NR 44

B

Buttons of the connection window 72

C

Clock functions 68
 Compact Flash 11
 Compatibility with S5-TCP/IP 7
 Connecting the CP to Ethernet 15
 Connecting the CP to PC/PG 15
 Connecting the Swing Cable 16
 Connection 27
 Connection window 56
 CONTROL 19

D

Do direct jobs always with all 45

F

FETCH 19
 FETCH active / FETCH passive 25
 Fetch on Event Cache Status 62
 FETCH on EVENT passive 26
 Firmware Update 71
 Flag word 45
 FTP Connection 49
 Functionality of handling blocks 20
 Function of the Switch 34

H

H1 connection 27
 H1 Parameter Settings 47
 Handling blocks 18
 Hardware 10

I

If Double connection the Other 44
 INAT PLC Header 32
 Initial Configuration of the S5-TCP/IP 100 37
 Installation 15

J

Job number 44
 Job Offset 44
 Job types 23
 Jumper 1100 14

L

LEDs 11

M

Menu Connection 59
 Menu Diagnosis 60
 Menu Extras 64
 Menu File 58
 Menu Functions 54
 Menu Help 72
 Menu Station 63
 Modbus table 51

N

Nomenclature INAT-Siemens 34

O

Offline 41

P

Page frame base address 39
 Parameterization 36
 PLC parameter settings 44

R

RECEIVE 19
 RECEIVE-ALL 19
 Receive job 21
 Remote TSAP 47
 Reset 11
 RFC1006 32

S

Scope of supply 6
 SEND 19
 SEND-ALL 19
 SEND / RECEIVE 23
 Send job 20
 Serial Parameterization 40
 Setting Parameters via IP or H1 38
 Setting up connection 43
 SNMP Settings 63
 Specifications 6
 Standard connections 51
 Standard job type 44

Station list 54
Station name 39
Station not found 54
Station parameter settings 39
Station password 39
Swing Cable 16
Switch 12
SYNCHRON 19

T

TCP/IP Connection 29
TCP/IP Parameter Settings 46
TCP/IP System Values 65
TSAP 47

W

WRITE active / WRITE passive 24